

FLOWMETERS - ROTAMETER

CAUDALÍMETROS - ROTÁMETROS

FEATURES

Flowmeters are transparent tubes with conical shape (narrow in its lower part and wider in the upper); they are installed in a perfectly vertical position along with the pipe of which we want to know the flow.

Within the tube there is a stainless steel floater, that will move upwards reaching a specific height depending on the weight of the floater and water pressure.

Thus, the greater is the flow, the higher will the floater move, marking a flow (l/h or GPM) in the scale which is stamped on the transparent tube.

- Available models from 10 to 1000 l/h (0,04 - 4,4 GPM).
- Assembly in vertical position.
- Union bushes in PVC-U.
- Tube in Styrene Methyl Methacrylate Copolymer.
- Measuring tube available in Polysulfon, Trogamid T[®], etc. upon request.
- Float stops in PVDF and floats in AISI 316.
- Maximum working temperature: 55°C (131°F) according to standards VDE / VDI 3531, class 6.
- Maximum pressure 15 bar.
- Two visible scales on each meter: l/h and GPM.
- Available upon request: limit switches and transmitters.
- Applications: process control in water treatment, osmosis, heating and refrigeration systems, chemical industries, pharmaceuticals, etc.

CARACTERÍSTICAS

Los caudalímetros son tubos transparentes con forma cónica (estrecho en su zona inferior y más ancho en su zona superior); se instalan en posición perfectamente vertical en serie con la tubería de la que se quiere conocer el caudal.

Dentro del tubo se encuentra un flotador de acero inoxidable, que se desplazará hacia arriba alcanzando una altura concreta que dependerá del peso del flotador y del empuje del agua.

Así, cuanto mayor es el caudal, más arriba se posicionará el flotador, marcando un caudal (l/h o GPM) en la escala que se encuentra marcada en el tubo transparente.

- Modelos disponibles desde 10 hasta 1000 l/h (0,04 - 4,4 GPM).
- Montaje en posición vertical.
- Racordaje en PVC-U.
- Tubo en metacrilato de metilo.
- Bajo pedido tubo de medida disponible en Polisulfon, Trogamid T[®], etc.
- Topes de flotador en PVDF.
- Flotador en AISI 316.
- Temperatura máxima de trabajo: 55°C (131°F) según normas VDE / VDI 3531, classe 6.
- Presiones hasta 15 bar.
- Doble escala visible en cada caudalímetro: l/h y GPM.
- Disponibles bajo pedido: automatismos y transmisores eléctricos.
- Aplicaciones: control de procesos en tratamiento de agua, osmosis, calefacción y refrigeración, industrias químicas, farmacéuticas, etc.

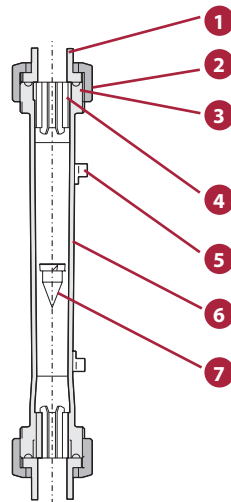
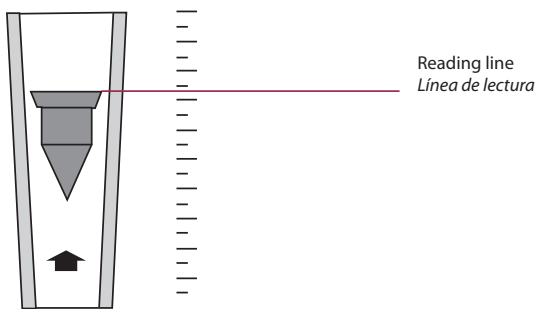

FIG.	Parts	Despiece	Material
1	Union end	Manguito enlace	PVC-U
2	Union nut	Tuerca	PVC-U
3	O-ring seal	Junta tórica	EPDM
4	Stops	Topes	PVDF
5	Indicator	Indicador	PE
6	Measuring tube	Tubo de medida	Methacrylate
7	Float	Flotador	AISI 316

OPERATION



FUNCIONAMIENTO

Chemical resistance chart
Tabla de resistencias químicas

Polymer type	Copolymer of styrene and methacrylate
Nomenclature	SMMA
CHEMICAL RESISTANCE	
Acetone	x
Unsaturated Oil	x
Saturated Oil	C
Mineral Oil	✓
Olive Oil	✓
Alcohol low molecular weight	C
Alcohol high molecular weight	✓
Diluted inorganic acid	✓
Concentrated inorganic acid	✓
Halogenated compound	x
Gasoline	x
Benzene	x
Toluene	x
Bleach	✓
Detergent	✓
Inorganic salts	✓

C: Conditioned resistance. In some cases the material may turn yellow, loose transparency or micro fissures could appear.

C: Resistencia condicional. En algunos casos puede darse amarillamiento, pérdida de la transparencia o formación de micro fisuras.

UP. 92. SF. M - FLOWMETER

Flowmeter

- Tube in Styrene Methyl Methacrylate Copolymer
- Female solvent socket

Caudalímetro

- Tubo en metacrilato de metilo
- Encolar hembra

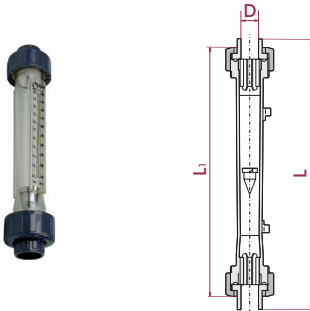

D	DN	REF.	CODE
20	15	05 92 020A	20205
20	15	05 92 020B	20206
20	15	05 92 020C	20207
25	20	05 92 025A	20208
25	20	05 92 025B	20209
25	20	05 92 025C	20210

GPM	l/h	L	L ₁
0,04 - 0,44	10 - 100	232	198
0,06 - 0,66	16 - 160	232	198
0,1 - 1,1	25 - 250	232	198
0,2 - 1,8	40 - 400	232	198
0,3 - 2,7	60 - 630	232	198
0,4 - 4,4	100 - 1000	232	198

UP. 92. FT. M - FLOWMETER

Flowmeter

- Tube in Styrene Methyl Methacrylate Copolymer
- BSP female thread

Caudalímetro

- Tubo en metacrilato de metilo
- Roscar hembra BSP

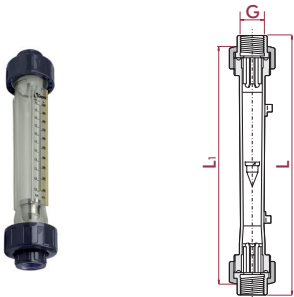

G	DN	REF.	CODE
½"	15	05 92 620A	20211
½"	15	05 92 620B	20212
½"	15	05 92 620C	20213
¾"	20	05 92 625A	20214
¾"	20	05 92 625B	20215
¾"	20	05 92 625C	20216

GPM	l/h	L	L ₁
0,04 - 0,44	10 - 100	232	198
0,06 - 0,66	16 - 160	232	198
0,1 - 1,1	25 - 250	232	198
0,2 - 1,8	40 - 400	232	198
0,3 - 2,7	60 - 630	232	198
0,4 - 4,4	100 - 1000	232	198

UP. 92. MT. M - FLOWMETER

Flowmeter

- Tube in Styrene Methyl Methacrylate Copolymer
- BSP male thread

Caudalímetro

- Tubo en metacrilato de metilo
- Roscar macho BSP

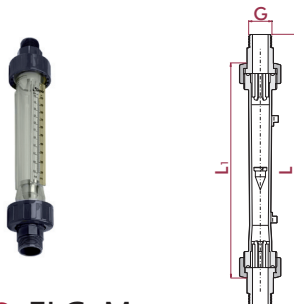

G	DN	REF.	CODE
½"	15	05 92 420A	20217
½"	15	05 92 420B	20218
½"	15	05 92 420C	20219
¾"	20	05 92 425A	20220
¾"	20	05 92 425B	20221
¾"	20	05 92 425C	20222

GPM	l/h	L	L ₁
0,04 - 0,44	10 - 100	249	198
0,06 - 0,66	16 - 160	249	198
0,1 - 1,1	25 - 250	249	198
0,2 - 1,8	40 - 400	252	198
0,3 - 2,7	60 - 630	252	198
0,4 - 4,4	100 - 1000	252	198

UP. 92. FLG. M - FLOWMETER

Flowmeter

- Tube in Styrene Methyl Methacrylate Copolymer
- With flanges

Caudalímetro

- Tubo en metacrilato de metilo
- Con bridas

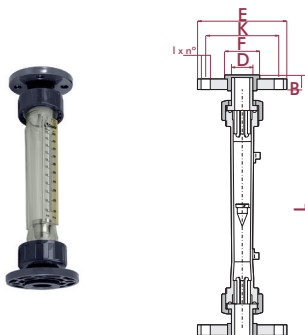

D	DN	REF.	CODE
20	15	05 92 220A	20223
20	15	05 92 220B	20224
20	15	05 92 220C	20225
25	20	05 92 225A	20226
25	20	05 92 225B	20227
25	20	05 92 225C	20228

GPM	l/h	E	K	F	l x n°	B	L
0,04 - 0,44	10 - 100	95	65	45	14x4	12	257
0,06 - 0,66	16 - 160	95	65	45	14x4	12	257
0,1 - 1,1	25 - 250	95	65	45	14x4	12	257
0,2 - 1,8	40 - 400	105	75	58	14x4	13	260
0,3 - 2,7	60 - 630	105	75	58	14x4	13	260
0,4 - 4,4	100 - 1000	105	75	58	14x4	13	260