

POOLDOSE DOUBLE

INSTRUCTIONS MANUAL **EN**

HANDBUCH **DE**

MANUAL DE INSTRUCCIONES **ES**

MANUEL D'INSTRUCTIONS **FR**

MANUALE D'INSTALLAZIONE **IT**



WARNING!

Before carrying out ANY work inside control panel of the PoolDose device, make sure you disconnect it from the power supply.

Failure to comply with the instructions contained in this manual could cause injury to people and/or damage to the appliance and the system.

1. PACKAGE CONTENT

A: PVC Crystal 4x6 suction hose (4 m)	B: Polyethylene delivery hose (5m)	C: FPM Lip valve (3/8" GAS)	D: PSS3 probe-holder (1/2" GAS)	E: Tapping saddle (φ=50mm)	F: Reducer for injection valve (1/2" M to 3/8" F)
G: Foot filter (PP riser)	H: Mounting bracket kit (φ=6 mm screws)	L: Temperature sensor	M: pH probe	N: ORP probe	O: Probes holder + Chlorine probe
P: Filter Minor (5") + PSS3 probe-holder (1/2" GAS)	Q: Cleaning brush chlorine probe	R: Balls for chlorine probe	S: pH 4 Buffer solution	T: pH 7 Buffer solution	U: 465 mv Calibration solution
V: Water					

Item*	System	Double pump system	
		PoolDose pH / ORP	PoolDose pH / ORP / CL
A		2	2
B		2	2
C		2	2
D		2	-
E		4(*1)	4(*1)
F		2	2
G		2	2
H		1	1
L		1 (*2)	1 (*2)
M		1	1
N		1	1
O		-	1
P		-	1
Q		-	1
R		-	1
S		1	1
T		1	1
U		1	1
V		1	1

*NOTE: The values from the table represent the number of items inside the package.

(*1 Five pieces for the WiFi model only)

(*2 One piece for the WiFi model only)

PoolDose | pH · ORP · Chlorine

WARNING!

These products are **DANGEROUS (I✳A)** and require special precautions during use, handling and storage.

- **NEVER mix chemical products.**
- NEVER allow children or people who have not read this manual to use or tamper with PoolDose or any of its peripheral components (including chemical products).

pH chemical products:

- **ABSOLUTELY** not recommended => pure sulphuric acid
- Recommended for lowering pH => negative pH (with a sulphuric acid base)
- Recommended for raising pH => positive pH (sodium carbonate or bicarbonate)

ORP chemical products:

- **ABSOLUTELY** not recommended => all types of organic chlorine
- Liquid chlorine or 12% bleach can be used neat. If the product has a concentration of 48%, it is necessary to dilute it in water in a 1:3 ratio.

The pH / ORP probes are subject to wear and tear and therefore are not covered by the warranty.

2. INSTALLATION INSTRUCTIONS

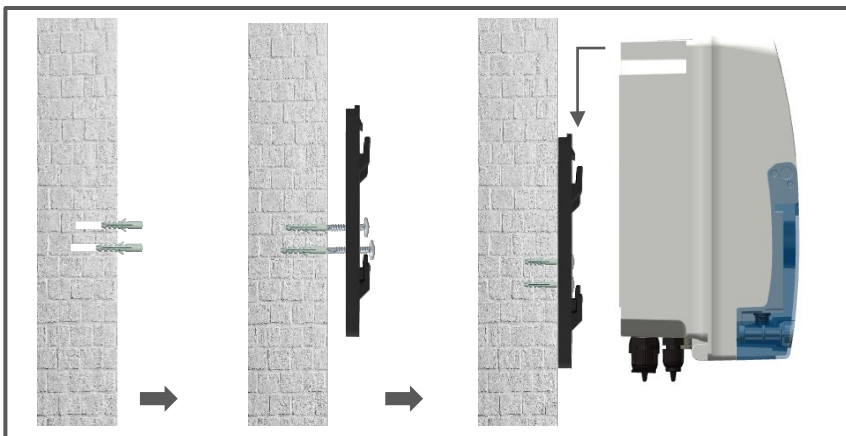

Make sure that the injection pressure is below 1.5 bar

Probe positioning

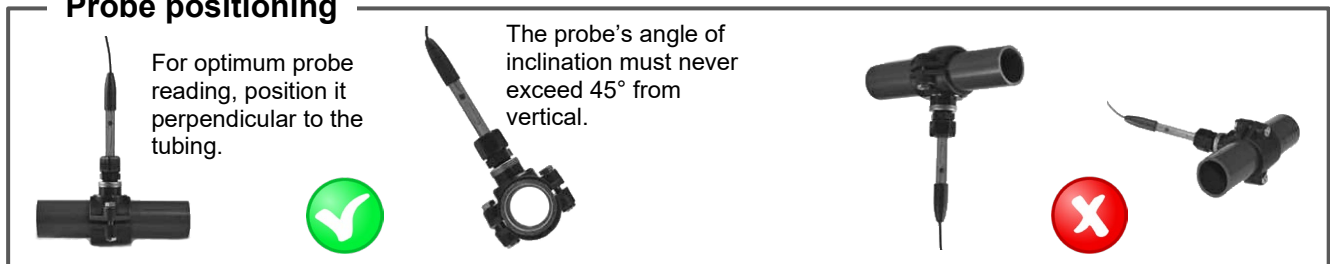

Installation plant

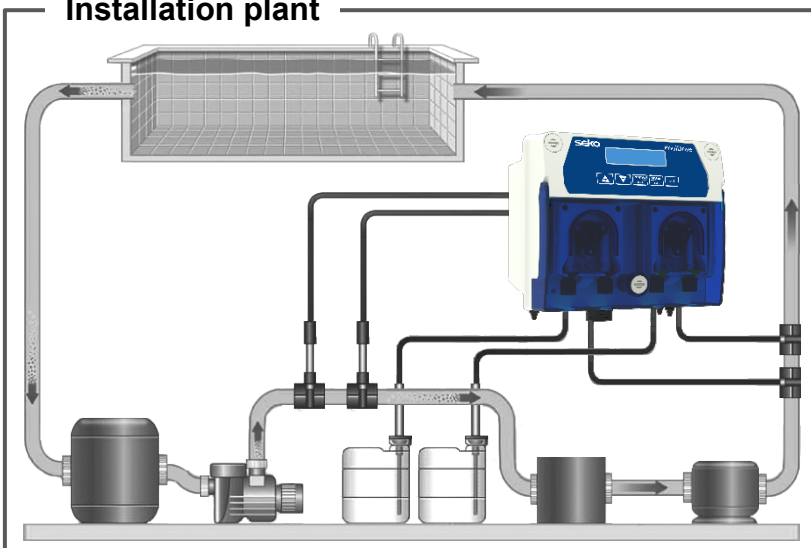

Warning!

Use with salt chlorinator:

For the pH systems, to prevent the risk of system malfunctioning or damage, observe the following instructions:

1. Position the pH measuring probe prior to the chlorinator cell.
2. To eliminate eddy currents, connect the pool water to an electrical ground point
3. Position the product injection point after the chlorinator cell.

3. ELECTRICAL CONNECTIONS

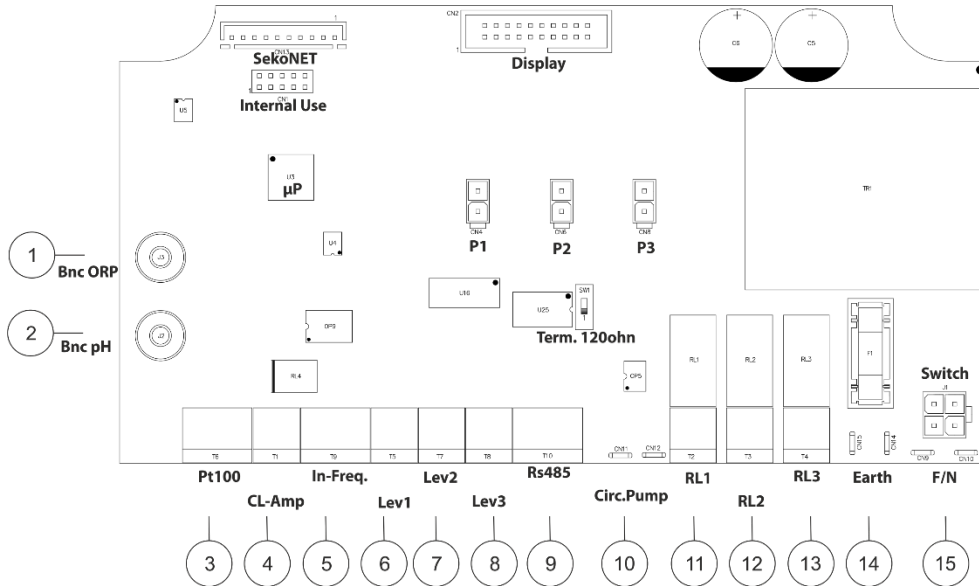

Clamp	Description	Double pump system	
		PoolDose pH · ORP	PoolDose pH · ORP · CL
1	Input Probe	ORP	ORP
2	Input Probe	pH	pH
3	Input Probe	TEMP (PT100)	TEMP (PT100)
4	Input Probe	Not used	Free Chlorine
5	Input Freq. signal	Flow Rate (Freq. Input)	Flow Rate (Freq. Input)
6	Level (product tank)	pH Level probe	pH Level probe
7	Level (product tank)	Chlorine (ORP) level probe	Chlorine level probe
8	Level (External Reed flow sensor)	Flow (REED sensor)	Flow (REED sensor)
9	Serial Port	Not present	Not present
10	Trigger Input 220Vac (High Voltage)	Circulation Pump (220Vac input)	Circulation Pump (220Vac input)
11	Output Relay R1	RL1 AUX1 pH	RL1 AUX1 pH
12	Output Relay R2	RL2 AUX2 OPR/Chlorine	RL2 AUX2 OPR/Chlorine
13	Output Relay R3	RL3 Alarm	RL3 Alarm
14	Earth connector	Earth	Earth
15	Power Supply	220-240 Vac 50-60 Hz (F/N)	220-240 Vac 50-60 Hz (F/N)
P1	Peristaltic pump connection	pH	pH
P2	Peristaltic pump connection	Chlorine (ORP)	Chlorine
P3	Peristaltic pump connection	Not used	Not used
SekoNet	WiFi Module	WiFi card (dedicate code)	WiFi card (dedicate code)

Label connections

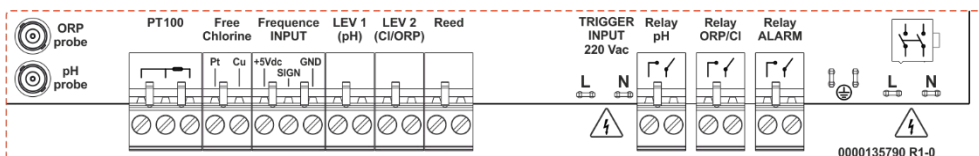

4. TECHNICAL SPECIFICATIONS

Specifications	PoolDose Double PH/ORP	PoolDose Double PH/ORP/Chlorine
Dimensions (H-W-D)	H:194.5 x W:205.1 x D:132.8 mm	H:194.5 x W:205.1 x D:132.8 mm
Weight	3.5 Kg	3.5 Kg
Pump state	Pause – Supply	Pause – Supply
Probe calibration	Automatic	Automatic
Power supply	220-240 VAC 50-60 Hz	220-240 VAC 50-60 Hz
Consumption (W)	28 Watt	28 Watt
Device precision	± 0.1 pH; ±10mV; ±1°C	± 0.1 pH; ±10mV; 0.1 ppm; ±1°C
Accuracy	±0.02pH, ±3mV; ±0,5°C	±0.02pH, ±3mV; 0,05 ppm; ±0,5°C
Range	0-14pH; -99 -1000mV; 0...+55°C	0-14pH; -99 -1000mV; 0-5 ppm; 0...+55°C
Flow rate pump (l/h)	1.5 l/h	1.5 l/h
Flow rate pump (SPA model only)	0.4 l/h	Not available
Max. back-pressure	1.5bar	1.5bar
Relay contact (number 3)	250 Vac 10A (resistive load)	250 Vac 10A (resistive load)
Fuse	500 mA (fast)	500 mA (fast)

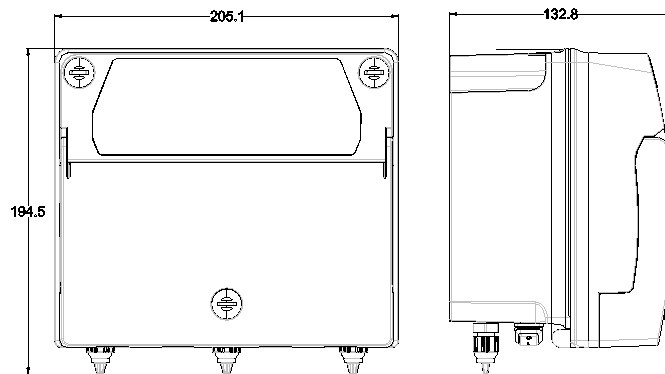

5. ELECTRICAL SUPPRESSOR DEVICE

It is mandatory to install the coil suppressor please below the instruction procedure:

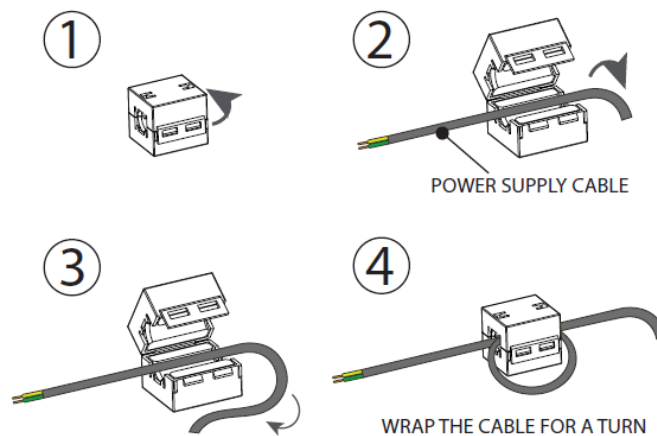

6. SETTING PROGRAM

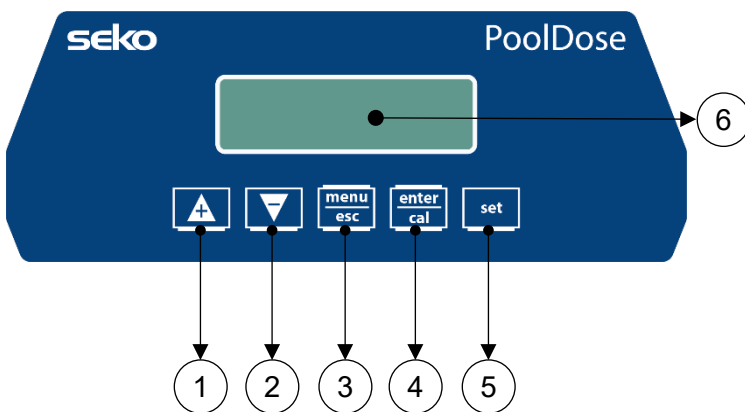

- 1) Button to increase the value
- 2) Button to decrease the value
- 3) Button Menu/Esc
- 4) Button Cal/OK
- 5) Button to set the setpoint
- 6) Digital display

Program Setup – Press **menu esc** for 5 seconds

At the entry of each menu item, the parameter can be directly modified using the arrow keys (**▲** and **▼**).

Confirmation of the current setting and switching to the next item is done by pressing the **enter cal** button.

The menu has a circular structure: once you arrive at last item, the confirmation of the parameter set by pressing **enter cal**, determines the return to the first menu item.

1 LANGUAGE – It is possible to select between 5 available languages: **EN**, **FR**, **IT**, **DE**, **ES**

2 PH

- **SETPOINT** – **7.2pH** (6-8pH)
- **SETPOINT TYPE:** – **Acid** (Acid/Alka)
- **TIME ON** = 30seconds (range from 1 to 360 seconds)
- **TIME OFF** = 60seconds (range from 1 to 360 seconds)
- **TEMPERATURE:** 25°C; set °C/°F and the manual value
- **OFA ALARM** Off, 1-60' (minutes)

* Timed dosing only

3 ORP

- **SETPOINT** – **700 mV** (400-850mV)
- **SETPOINT TYPE:** **Low** (Low/High)
- **TIME ON** = 30seconds (range from 1 to 360 seconds)
- **TIME OFF** = 60seconds (range from 1 to 360 seconds)
- **OFA ALARM** Off, 1-60' (minutes)
- **Note:** The ORP dosing, in the presence of Chlorine has no effect on the dosing pump, but can handle the Aux2 Relay with ON/OFF activation with respect to the setpoint.

* Timed dosing only

4 CHLORINE

- **SETPOINT** – **1.2 ppm**(0.3-3.0 ppm)
- **SETPOINT TYPE:** **Low** (Low/High)
- **TIME ON** = 30seconds (range from 1 to 360 seconds)
- **TIME OFF** = 60seconds (range from 1 to 360 seconds)
- **OFA ALARM** Off, 1-60' (minutes)

* Timed dosing only

5 ADVANCED MENU

- **CIRCULATION PUMP** – (Enabled/Disabled)
- **IN FREQ** (Input flow rate)
 - ON-OFF
 - Pulse/Liter:1 or Liter/pulse:1 – Set value
 - Unit: L or m³
- **CALIBRATION PH:** 2 points, 1 point, Reference, Disable
- **CALIBRATION ORP:** 1 point, Reference, Disable

PoolDose | pH · ORP · Chlorine

- CALIBRATION CL: 2 points, Disable,
- CALIBRATION TEMP: Reference, Disable,
- DOSING TYPE PH: Proportional, OFF, **CYCLE**, Timed, On/OFF
 - **Note:** Cycle dosing mode, it is present in the PoolDose SPA application only.
- DOSING TYPE ORP: Proportional, OFF, **CYCLE**, Timed, On/OFF,
 - **Note:** The ORP dosing is disabled if DOSING TYPE CHLORINE is different than OFF
 - **Note:** Cycle dosing mode, it is present in the PoolDose SPA application only.
- DOSING TYPE CHLORINE: Proportional, OFF, Timed, On/OFF
- AUX RELAY
 - AUX1 RELAY: pH, Disable
 - AUX2 RELAY: Chlorine, ORP, Disable
 - **Note:** Aux1 and Aux2 relays dose with ON/OFF method
- PASSWORD: 0000 (**Note:** password disabled, set a value other than: 0000)
- RESET CALIBRATION: (**Note:** select the measure to reset: pH; Chlorine; ORP)
- RESET ALL PARAMETERS: RESET DEFAULT PARAMETERS
- CONTROL PANEL: displays the electrical signals
- WFI CONFIGURATION
 - WiFi network name
 - WiFi password
 - WiFi network IP address.

Note: this menu is available for WiFi product only, it is not present in the PoolDose SPA application.
- REED (display error, when reed off): NO/NC
- POWER ON DELAY: Disables the dosing pumps for the set time (OFF...1:90 minutes)
- FLOWDELAY: Disables the dosing pumps for the set time (OFF...1:60 minutes)

Note: Timeout for settings menu - after 120 seconds without action the controller escape itself without saving parameters.

View Parameters

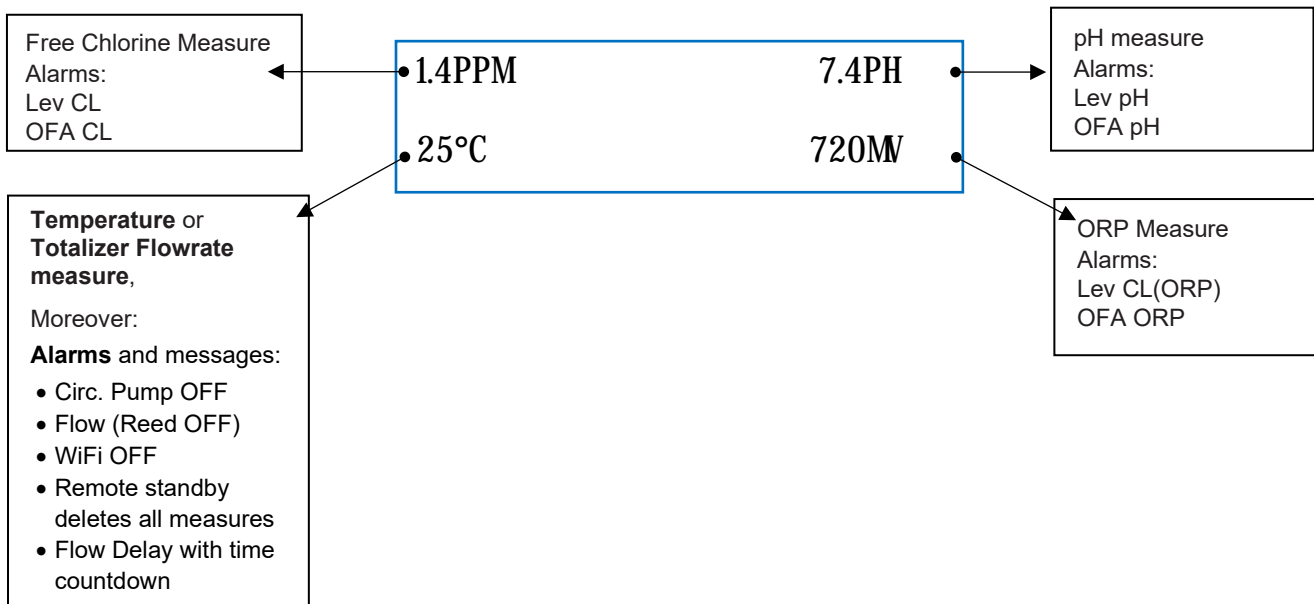

PoolDose SPA View Parameters

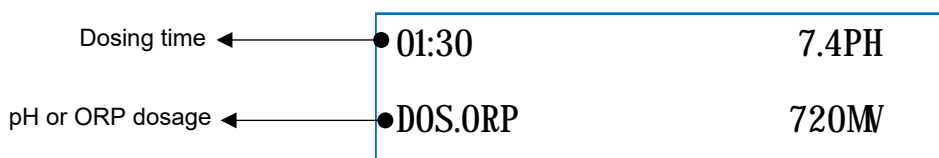









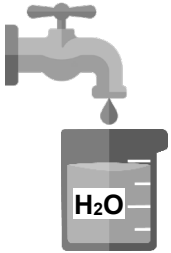

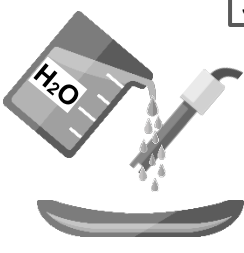
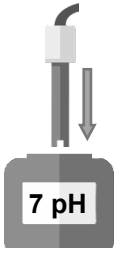
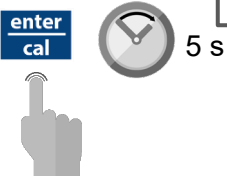

PoolDose | pH · ORP · Chlorine

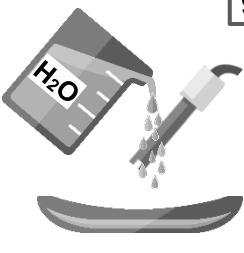
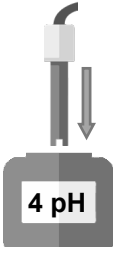
Calibration Menu:

Press  (3 seconds) and calibrate probe pH, Chlorine, Temperature, ORP

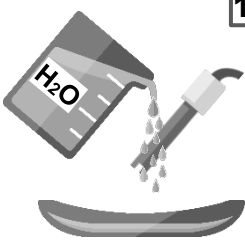
7. pH CALIBRATION

 <p>1</p>	 <p>2</p>	 <p>3</p>	 <p>4</p>
 <p>5</p> <p>Set pH calibration</p>	 <p>6</p> <p>7 pH calibration</p>	 <p>7</p> <p>90 s</p>	 <p>8</p>
 <p>9</p>	 <p>10</p>	 <p>11</p> <p>4 pH calibration</p>	 <p>12</p> <p>90 s</p>
 <p>13</p>	 <p>14</p>	 <p>15</p>	 <p>16</p> <p>Save and exit</p>

Note: If you have selected the “1 point cal.”, the calibration will be made only in 1 point using the 7pH buffer solution.

Reference calibration

CAL Reference
7.2 pH

The unit will flash a pH value
Set the temperature
measured with the instrument
Ex. 7.4 pH

CAL Reference
7.4 pH



8. ORP CALIBRATION

Reference calibration











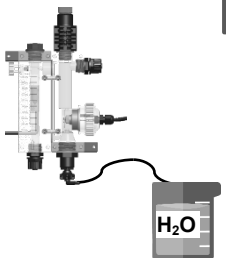
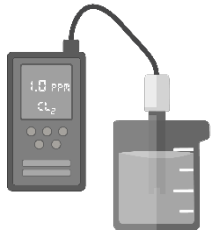
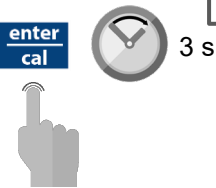

CAL Reference
720 mV

The unit will flash a redox value
Set the value measured with
the instrument
Ex. 750 mV

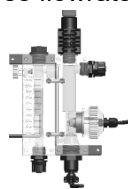
CAL Reference
750 mV

enter
cal

9. CHLORINE CALIBRATION

 <p>1</p>	 <p>2</p>	 <p>3 s</p> <p>Select Cl calibration</p>	 <p>4</p>
 <p>5</p> <p>10 s</p>	 <p>6</p> <p>The unit will flash a Cl value Set the Cl value measured with the instrument Ex. 1.0 ppm Free Cl</p>	 <p>7</p> <p>1.0 PPM</p> <p>enter cal</p>	 <p>8</p> <p>10 s</p>
<p>Close flowrate</p>  <p>10</p>	<p>Confirm that the flow closed by moving the choice to Yes and confirming with CAL</p>  <p>11</p>	 <p>12</p> <p>100 s</p>	 <p>13</p>
 <p>14</p> <p>10 s</p>	<p>Calibration OK!</p>  <p>15</p>		

* Press ESC to exit the calibration menu.

10. TEMPERATURE CALIBRATION

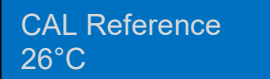
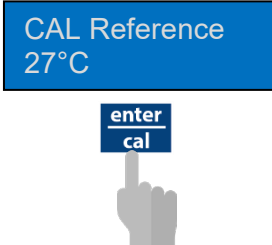
 <p>CAL Reference 26°C</p> <p>The unit will flash a temperature value Set the temperature value measured with the instrument Ex. 27°C</p>	 <p>CAL Reference 27°C</p> <p>enter cal</p>
--	--

PoolDose | pH · ORP · Chlorine

Set menu

Press **set** (3 seconds) and adjust set point value and press SET to confirm.

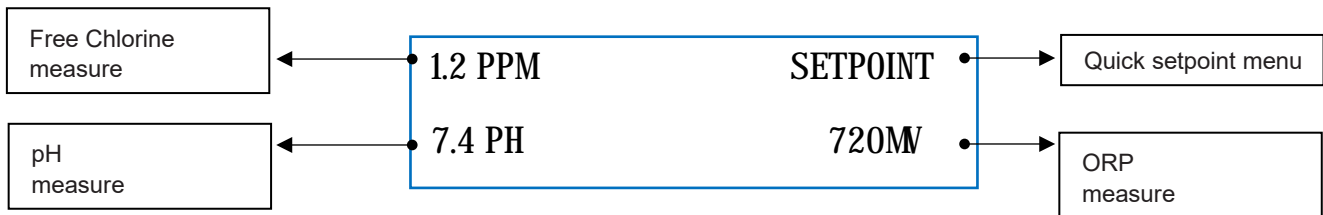

Calibration Menu

Press **enter cal** (3 seconds) and calibrate probe pH, Chlorine, Temperature, ORP.

StandBy system

Press **▼ ▲** (5 seconds) the system sets in StandBy mode; all functions are disabled.

Reset OFA Timer

Press **menu esc** (3 seconds) to reset OFA Alarm or press **▲ ▼** (5 seconds) to reset OFA Alarm.

Priming pumps

Only while the pump is in “stand-by mode” press down **▲** to reset flow totalizer, **▼** to run pH pump, press **menu esc** to run ORP/Chlorine pump, press **enter cal** to run the Aux1 Relay, press **set** to run the Aux2 Relay.

PoolDose SPA dosage

The regulation of pH and chlorine in the PoolDose Spa system is managed by keeping the pH regulation prior to the chlorine dosage to obtain a better regulation. This function is only available on PoolDose SPA products.

To restore the default parameters, follow the steps below:

- Power off the PoolDose unit
- Keep **▲** and **▼** pressed and power on the unit
- The unit will display **INIT.DEFAULT**
- Select the unit to reset - WiFi module or dosing system
- Press **▲** or **▼** to select **YES** or **NO**
- Select **YES** and press **enter cal** to restore the default parameters.

Default parameters:

- Language = **EN**
- Set Point value = **7.2 pH; 700 mV; 1.2 ppm**
- Dosing method = **Acid (pH); Low (Redox); Low (Cl)**
- OFA Time = **OFF**
- Calibration = **Full**
- Flow Input = **OFF (recirculation pump)**
- Dosing type = **PROP; ON/OFF Relay Aux1 and Aux2**
- IN Freq. = **OFF**
- Reed = **NC (normally closed)**
- P.ON (On delay) = **OFF**
- Flow delay = **OFF**

11. DOSING METHOD

Setpoint = 7.2 pH
Dosing mode = Acid
Prop. Band= 1.0 pH (* Fixed value)

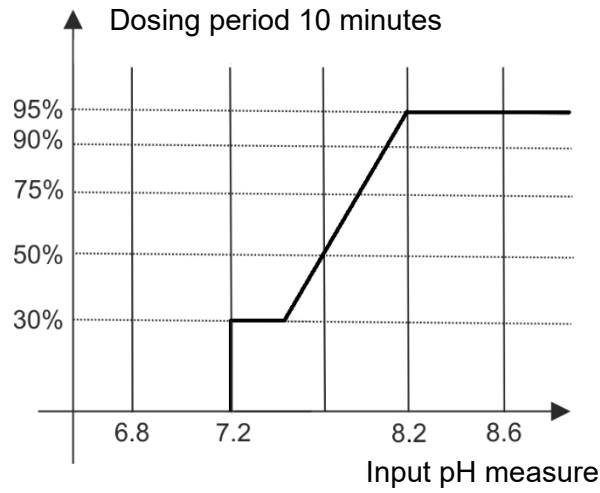

Setpoint = 700 mV
Dosing mode = Low
Prop. Band= 250mV (* Fixed value)

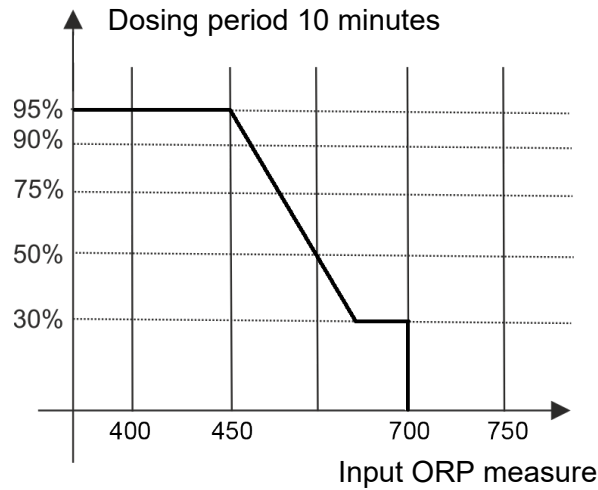

Setpoint = 1.2ppm free Chlorine
Dosing mode = Low
Prop. Band: 0.8ppm (* Fixed value)

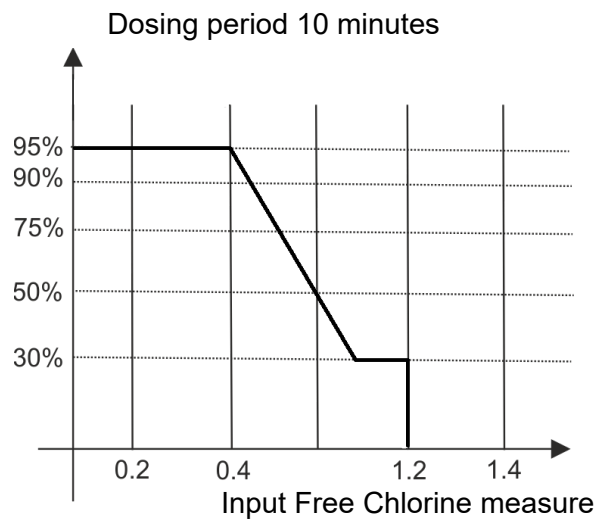

12. CYCLE DOSING METHOD

The cycle dosing method is available in the PoolDose SPA model only

The cycles should be following:

- 20 minutes wait

- 4 min cyclus of dosing in proportioning for pH dosing(if pH doesn't requires dosing, the system can manage dosage for Rx if needed) (priority to pH)

- 20 minutes wait

- 4 min cyclus of dosing in proportioning for pH dosing(if pH doesn't requires dosing, the system can manage dosage for Rx if needed) (priority to pH)

Exct.

Proportionally means:

Timeframe is 60 seconds:

As the reading is at 90 % of the setpoint the time of running is 14 seconds

As the reading is at 75 % of the setpoint, the time of running is 20 seconds

As the reading is at 50 % of the setpoint, the time of running is 30 seconds

As the reading is at 25 % of the setpoint, the time of running is 40 seconds

PoolDose | pH · ORP · Chlorine

Alarm for the pH/ORP Set Point

When the alarm band is set, a work window is created. If the allowed limits are exceeded the alarm relay closes and remains closed until the measurement is reset or **enter cal** is pressed to deactivate the alarm.

When the OFA time (Over Feed Alarm) is set, the dosing time of Set Point pH/ORP in time is controlled with two alarms:

- First alarm at 70% of the time set is seen on the display, the alarm relay closes.
- Second alarm at 100% of the time set is seen on the display and the alarm relay closes and the pH/ORP pump is blocked.

Press **menu esc** (3 seconds) to reset OFA Alarm or press **▲ ▼** (5 seconds) to reset OFA Alarm.

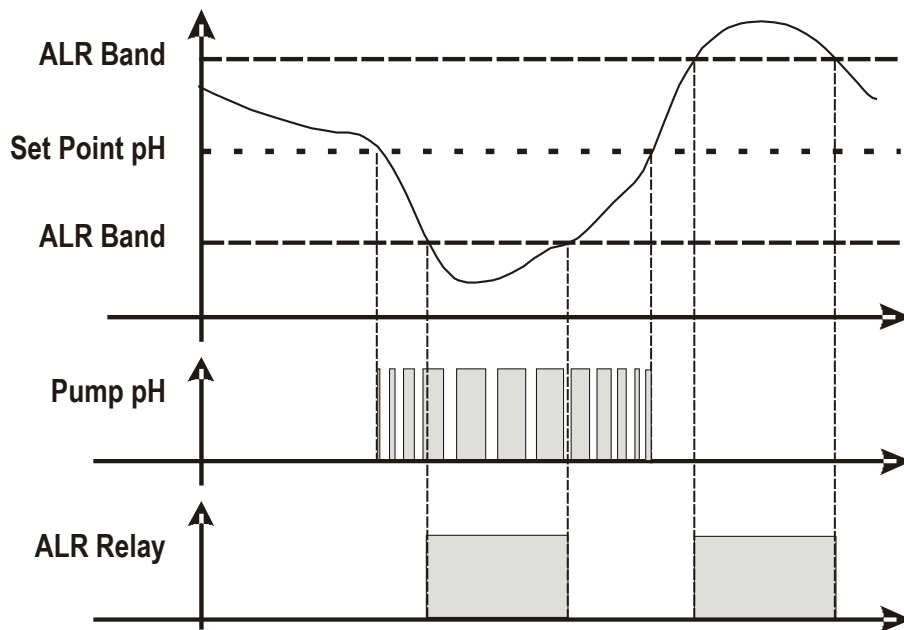

(*1 Measure alarm Ranges - fixed values)

n	Item	Limits
1	Temp. Measure min	+ 10°C
2	Temp. Measure Max	+ 38°C
3	pH Measure min	6 pH
4	pH Measure Max	8 pH
5	ORP Measure min	+ 600 mV
6	ORP Measure Max	+ 800 mV
7	CL Measure min	0,50 ppm
8	CL Measure Max	2 ppm

13. INTERNAL WEB SERVER

Download **SekoLink**

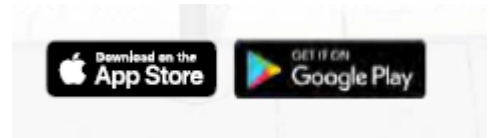

Register your account

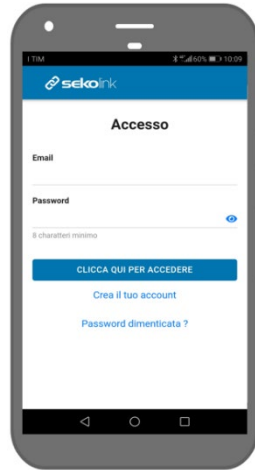

Thanks to QrCode login in internal webpages

Set:

User name= ADMIN

Password= 0000



Set your WiFi lan name and Password and confirm.



Complete your device registration

PoolDose | pH · ORP · Chlorine

Thanks to your registration it is possible to use **sekolink** and **sekoweb**.



sekolink

Thanks to **sekolink** it is possible to manage your pool:

- Monitoring and limited management
- Smartphone app compatible with iPhone or Android
- For end users









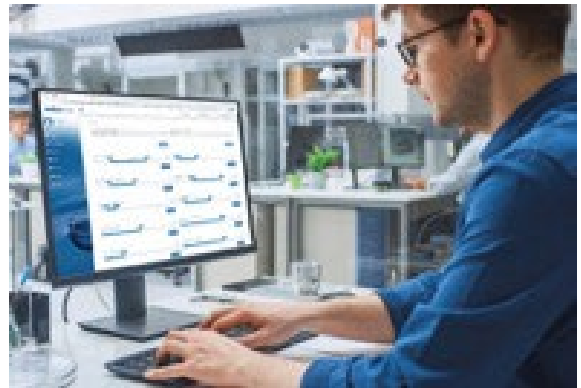



sekoweb

Use **sekoweb** address link www.sekoweb.com or APP to manage your pools with professional webportal:

- Monitoring and complete management
- Internet portal accessible via online login or by scanning a product's QR code
- For pool and spa installers, technicians and engineers



14. ALARMS

Alarm	Display	Actions to do
Level *only active measures	LEV LOW	- Push  to open Alarm Relay - Restore Product tank
Out of Range measure	ALARMBAND	- Replace or check the measure probe - Push  to open Alarm Relay - Restore measure
OFA First Alarm (time >70%)	OFA_1	- Press  for 3 seconds to reset or press   for 5 seconds to reset
OFA Second Alarm (time 100%)	OFA_2	- Press  for 3 seconds to reset or press   for 5 seconds to reset
Flow Rate	FLOW	- Restore Flow Rate
Calibration Function	CALIBRATION ERR	- Restore Probe or Buffer solution and repeat calibration procedure
System Error	PARAMETERS ERROR	- Press  to restore Default parameter - Broken Unit
Alarm measure (*1)	HIGH MEASURE LOWMEASURE	- Adjust the chemical concentration
WiFi Menu is not present in the advanced menu, but WiFi card is present	WIFI MENU IS NOT PRESENT	- Switch off the unit, keep pressed  and switch on.
Error Measure	WRONG MEASURE	- Please, reset the calibration parameter, into Advanced Menu click to <u>Reset CAL Item</u> .

(*1 Measure Alarm Ranges)

n	Item	Limits
1	Temp. Measure min	+ 10°C
2	Temp. Measure Max	+ 38°C
3	pH Measure min	6 pH
4	pH Measure Max	8 pH
5	ORP Measure min	+ 600 mV
6	ORP Measure Max	+ 800 mV
7	CL Measure min	0,50 ppm
8	CL Measure Max	2 ppm

15. HANDLING

Hose replacement:

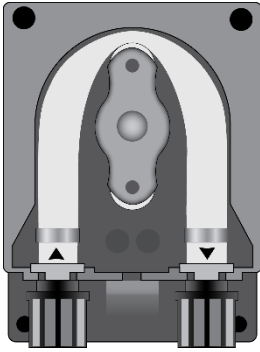

Open the pump's lid and release the hose by pulling the left connector upward.

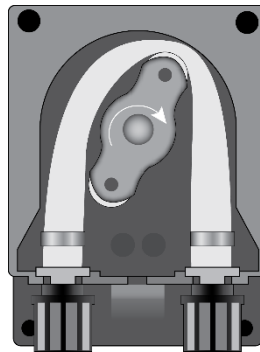

Position the roller at 7h05, turning it in the direction of the circular arrow.

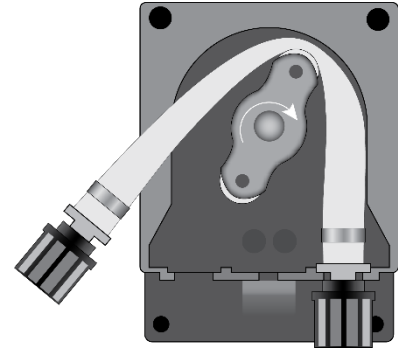

Completely release the left connector, holding it taut towards the outside, and turn the roller in the direction of the circular arrow so that the hose is freed up to the right connector.

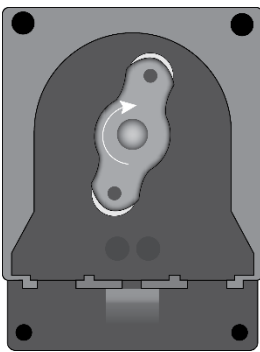

Position the roller at 7h05, turning it in the direction of the circular arrow.

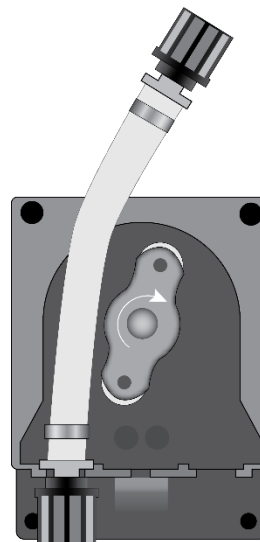

Insert the left connector into the relative housing and pass the hose under the roller's guide. Turn the roller in the direction of the circular arrow, simultaneously accompanying the hose into the pump's head, until the right connector is reached.

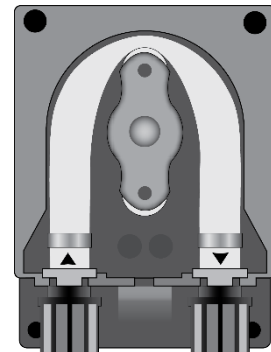

Close the pump's lid and press its surface hard so that it is properly locked into place.

*Tube replacement procedure valid for 2 and 3 rollers.

16. STORING THE PUMP AFTER USE

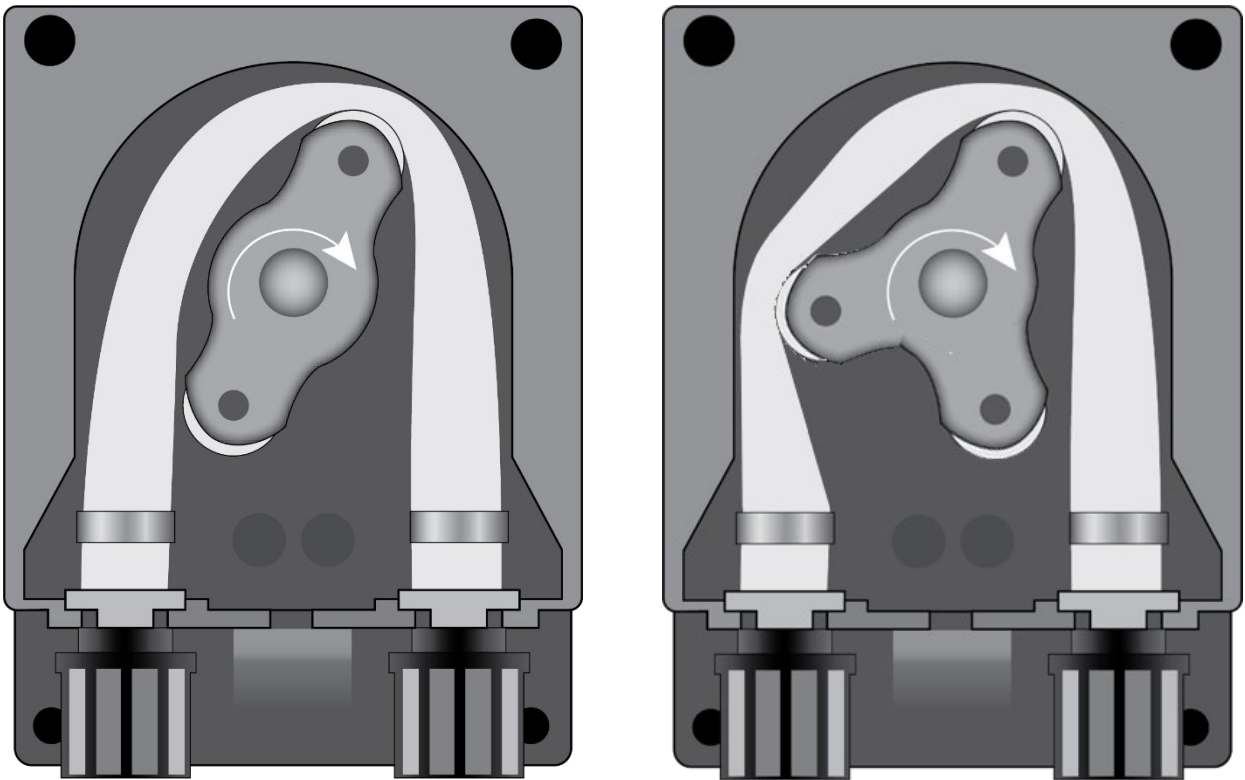

When the regulation device must be stored, clean water should be pumped through the hose in order to rinse it. Then position the roller at 7h05, turning in the direction indicated by the circular arrow. These two precautions will facilitate the subsequent reactivation of the unit.

PoolDose | pH · ORP · Chlorine

Wires connection:

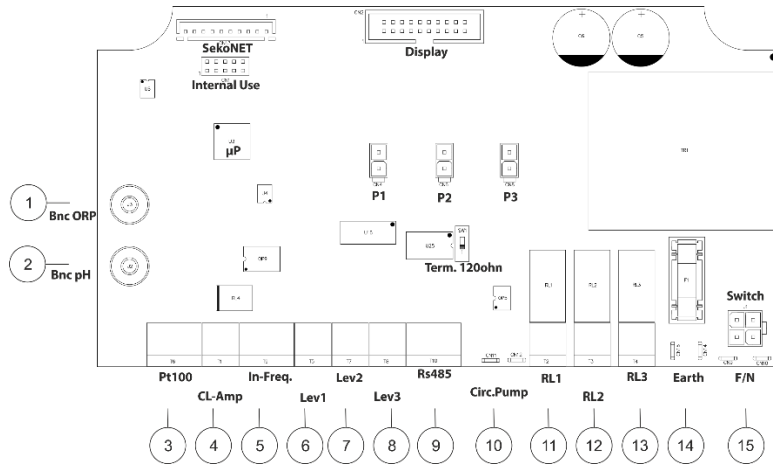

Label connection:

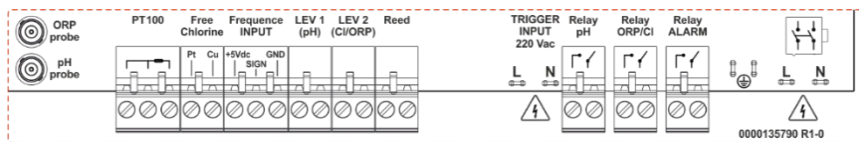

Clamp	Description	PoolDose pH · ORP	
1	Input Probe	ORP	ORP Probe
2	Input Probe	pH	pH Probe
3	Input Probe	TEMP (PT100) A= two wires sensor B= three wires sensor	
4	Input Free Chlorine sensor	Input free chlorine probe: Pt: Platinum sensor Cu: Cupper sensor	
5	Input Freq. signal	Flow Rate (Freq.Input) A= Mechanical reed B= Padwheel hall sensor	
6	Level (product tank)	pH Level probe	Level probe for chemical tank
7	Level (product tank)	Chlorine (ORP) level probe	Level probe for chemical tank
8	Level (product tank)	Flow (REED sensor)	Flow Sensor
9	Serial Port	Not present	None
10	Trigger Input	Circulation Pump (220Vac input)	Fase/Neutral wires
11	Output Relay	RL1 AUX1 pH	Dry contact
12	Output Relay	RL2 AUX2 OPR/Chlorine	Dry contact
13	Output Relay	RL3 Alarm	Dry contact
14	Earth connector	Earth	---
15	Power Supply	220-240 Vac 50-60 Hz (F/N)	---



ACHTUNG!

Vor jeder Maßnahme innerhalb der Steuertafel des PoolDose ist sicherzustellen, dass diese Vorrichtung vom Netz getrennt ist.

Die Nichteinhaltung der in dieser Anleitung enthaltenen Anweisungen kann zu Personenschäden, Schäden am Gerät und Schäden am System führen.

1. LIEFERUMFANG

 A: PVC Crystal 4x6 mit Ansaugschlauch (4 m)	 B: Polyäthylen-Auslassschlauch (5m)	 C: FPM-Lippventil (3/8" Gas)	 D: PSS3-Sondenträger (1/2" Gas)	 E: Selbstschneidende Rohrschlauchklemme (φ=50mm)	 F: Reduzierstück für Einspritzventil (1/2" außen auf 3/8" innen)
 G: Fußfilter (PP-Rohr)	 H: Halterungssatz (φ= 6 mm-Schrauben)	 L: Temperaturfühler	 M: pH-Sonde	 N: Redox-Sonde	 O: Sondenträger + Chlorsonde
 P: Minorfilter (5") + PSS3-Sondenträger (1/2" Gas)	 Q: Reinigungsbürste für Chlorsonde	 R: Kugeln für Chlorsonde	 S: Pufferlösung pH 4	 T: Pufferlösung pH 7	 U: Kalibrierlösung 465 mV
 V: Wasser					

System / Artikel *	Doppelpumpensystem	
	PoolDose pH / ORP	PoolDose pH / ORP / CL
A	2	2
B	2	2
C	2	2
D	2	-
E	4 ^(*1)	4 ^(*1)
F	2	2
G	2	2
H	1	1
L	1 ^(*2)	1 ^(*2)
M	1	1
N	1	1
O	-	1
P	-	1
Q	-	1
R	-	1
S	1	1
T	1	1
U	1	1
V	1	1

* Die Zahlen in der Tabelle geben die Anzahl der jeweiligen Artikel im Lieferumfang an.

(*1 Fünf Ein Stücke für das WiFi-Modell)

(*2 Ein Stück für das WiFi-Modell)

PoolDose | pH · ORP · Chlor

ACHTUNG!

Diese Produkte sind **GEFÄHRLICH (I✳A)** und der Umgang mit ihnen, der Gebrauch und die Lagerung erfordern besondere Vorsichtsmaßnahmen.

- **Chemikalien niemals miteinander vermischen!**
- Niemals Kinder oder mit dieser Anleitung nicht vertraute Personen die PoolDose oder zugehörige Komponenten einschließlich der Chemikalien verwenden oder damit hantieren lassen.

pH-Werte der Chemikalien

- **Absolut** nicht empfohlen => reine Schwefelsäure
- Zum Senken des pH-Werts wird negativer pH-Wert empfohlen (auf der Grundlage von Schwefelsäure).
- Zum Erhöhen des pH-Werts wird positiver pH-Wert empfohlen (Natriumcarbonat oder Bicarbonat)

Redox-Chemikalien

- **Absolut** nicht empfohlen: Alle Arten organischer Chlorverbindungen
- Flüssige Chlorverbindungen und 12%-Bleichmittel sind ohne weiteres verwendbar. Mittel mit 48%-iger Konzentration müssen im Verhältnis 1:3 in Wasser gelöst werden.

Alle pH- und Redoxsonden sind Verschleißteile und daher von jeglicher Garantie ausgeschlossen.

2. EINBAUANLEITUNG

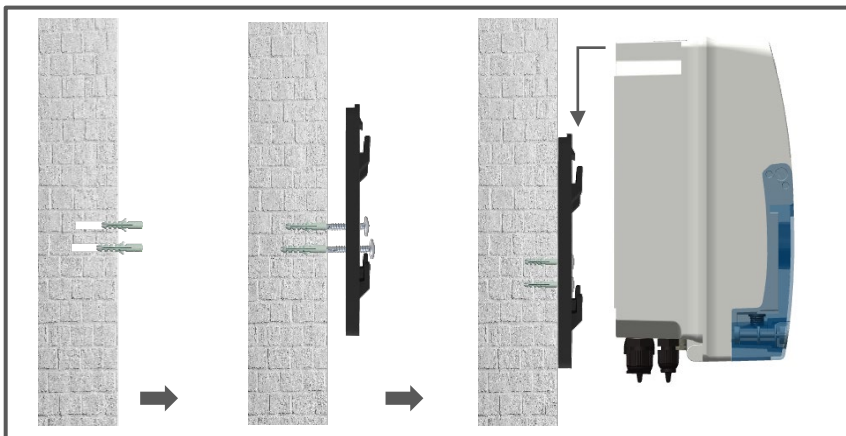

Vergewissern Sie sich, dass der Einspritzdruck weniger als 1,5 bar beträgt!

Anordnung der Messsonde

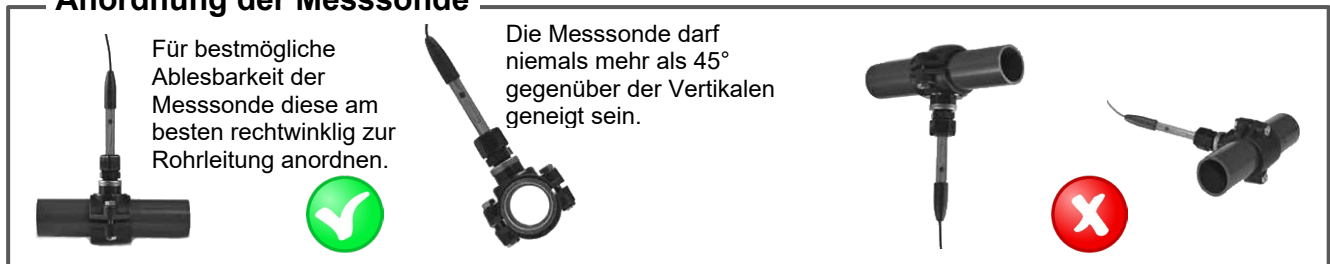

Anlagenaufbau

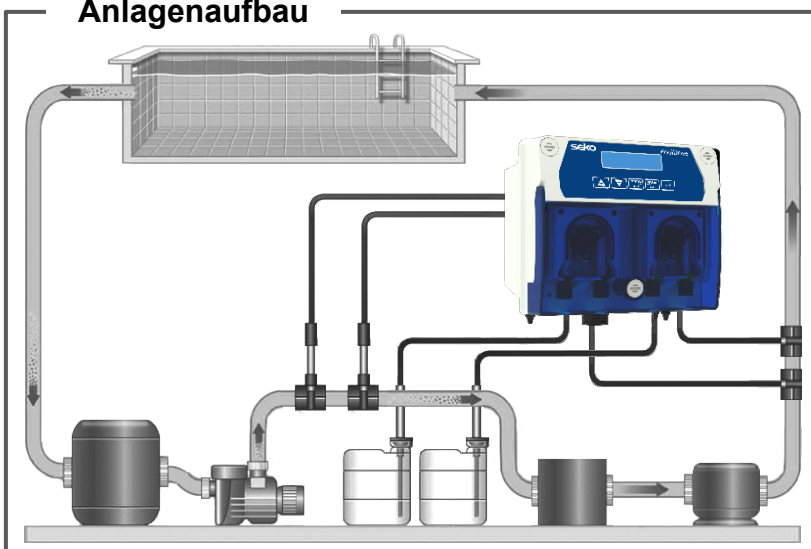

Achtung!

Verwendung mit Salzchlorungsmittel

Um bei pH-Systemen Systemstörungen und Systemschäden vorzubeugen, ist Folgendes zu beachten:

1. Die pH-Messsonde vor der Chlorierungszelle anordnen.
2. Zur Vermeidung von Fehlerströmen das Poolwasser erden.
3. Den Einspritzzeitpunkt für das Mittel hinter der Chlorierungszelle anordnen.

3. ELEKTROANSCHLÜSSE

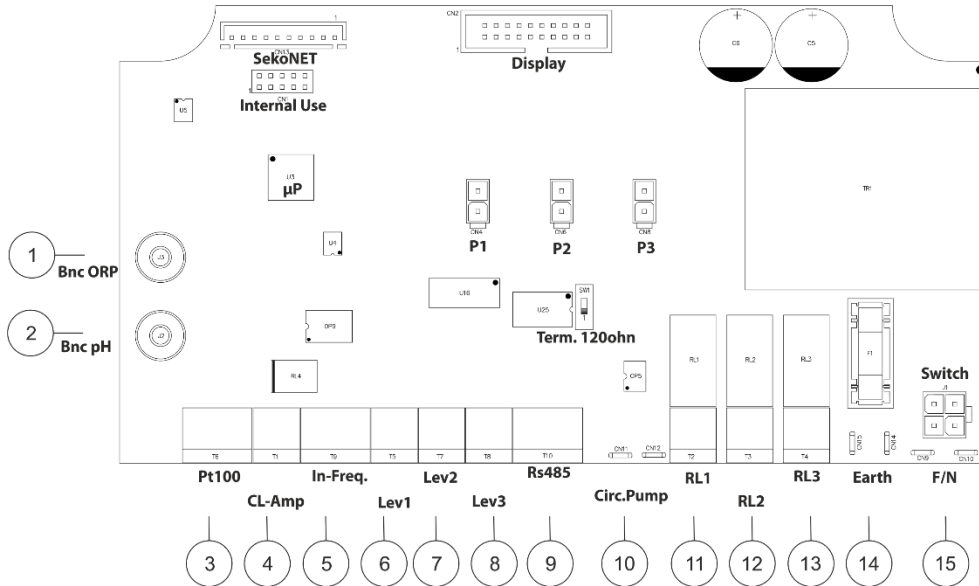

Klemme	Beschreibung	Doppelpumpensystem	
		PoolDose pH · ORP	PoolDose pH · ORP · CL
1	Einlasssonde	ORP	ORP
2	Einlasssonde	pH	pH
3	Einlasssonde	TEMP (PT100)	TEMP (PT100)
4	Einlasssonde	Nicht benutzt	Freies Chlor
5	Eingangsfrequenz Signal	Durchfluss (Freq. Eingang)	Durchfluss (Freq. Eingang)
6	Füllstand (Produktbehälter)	pH Füllstandssonde	pH Füllstandssonde
7	Füllstand (Produktbehälter)	Chlor (ORP) Füllstandssonde	Chlor Füllstandssonde
8	Füllstand (externer Reed-Durchflusssensor)	Durchfluss (REED Sensor)	Durchfluss (REED Sensor)
9	Serielle Schnittstelle	Nicht vorhanden	Nicht vorhanden
10	Triggereingang 220Vac (Hochspannung)	Umwälzpumpe (Eingang 220Vac)	Umwälzpumpe (Eingang 220Vac)
11	Ausgangsrelais R1	RL1 AUX1 pH	RL1 AUX1 pH
12	Ausgangsrelais R2	RL2 AUX2 ORP/Chlor	RL2 AUX2 ORP/Chlor
13	Ausgangsrelais R3	RL3 Alarme	RL3 Alarme
14	Erdungsanschluss	Erdung	Erdung
15	Stromversorgung	220-240 Vac 50-60 Hz (F/N)	220-240 Vac 50-60 Hz (F/N)
P1	Peristaltische Pumpenanschluss	pH	pH
P2	Peristaltische Pumpenanschluss	Chlor (ORP)	Chlor
P3	Peristaltische Pumpenanschluss	Nicht benutzt	Nicht benutzt
SekoNet	WiFi-Modul	WiFi-Karte (separater Produktcode)	WiFi-Karte (separater Produktcode)

Beschrifteten Verbindungen

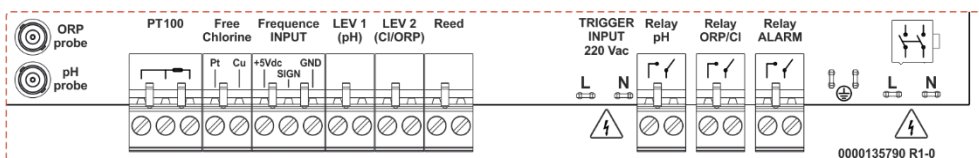

4. TECHNISCHE DATEN

Daten	PoolDose Double pH/ORP	PoolDose Double pH/ORP/Chlor
Abmessungen (H-B-T)	H:194,5 x B:205,1 x T:132,8 mm	H:194,5 x B:205,1 x T:132,8 mm
Gewicht	3,5 Kg	3,5 Kg
Pumpenstatus	Unterbrechung - Ein	Unterbrechung - Ein
Sondenkalibrierung	Automatisch	Automatisch
Stromversorgung	220-240 VAC 50-60 Hz	220-240 VAC 50-60 Hz
Leistungsaufnahme	28 Watt	28 Watt
Genauigkeit des Geräts	± 0,1 pH; ±10mV; ±1°C	± 0,1 pH; ±10mV; 0,1 ppm; ±1°C
Genauigkeit	±0,02pH, ±3mV; ±0,5°C	±0,02pH, ±3mV; 0,05 ppm; ±0,5°C
Bereich	0-14pH; -99 -1000mV; 0...+55°C	0-14pH; -99 -1000mV; 0-5 ppm; 0...+55°C
Durchflussmenge Pumpe	1,5 l/h	1,5 l/h
Durchflussmenge Pumpe (nur SPA-Modell)	0,4 l/h	Nicht verfügbar
Maximaler Gegendruck	1,5bar	1,5bar
Relaiskontakt (Nummer 3)	250 Vac 10A (ohmsche Last)	250 Vac 10A (ohmsche Last)
Sicherung	500 mA (schnelle)	500 mA (schnelle)

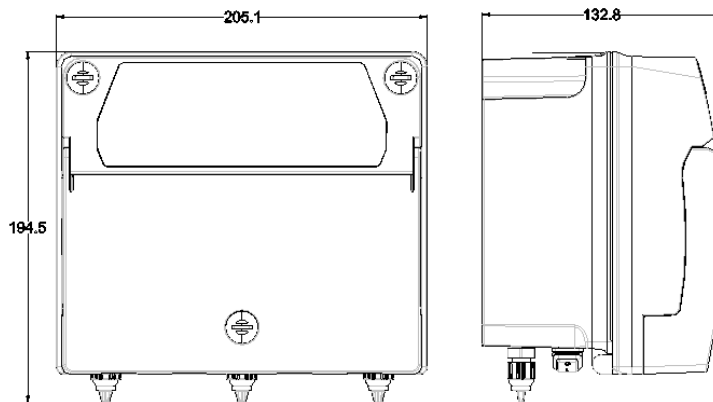

5. ELEKTRISCHE UNTERDRÜCKUNGSVORRICHTUNG

Es ist obligatorisch, den Spulenunterdrücker zu installieren, bitte folgen Sie der Anleitung:

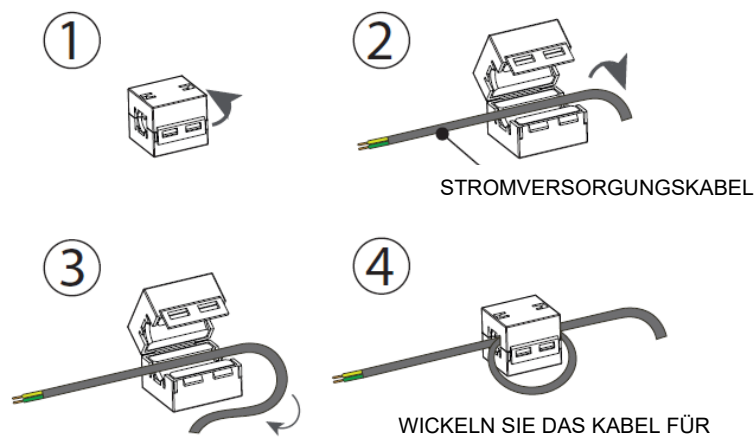

6. SETUP-ANLEITUNGEN

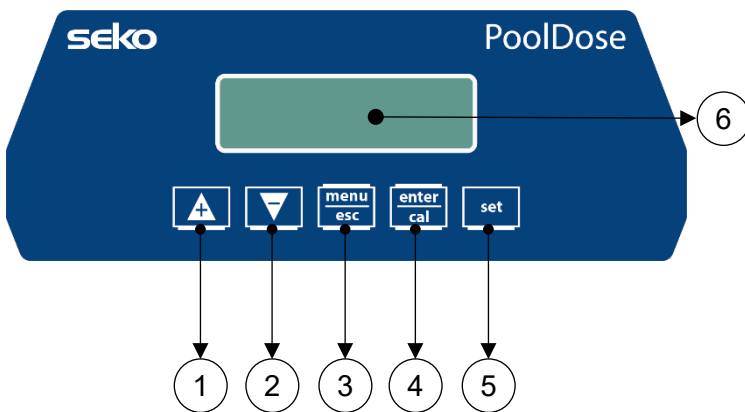

- 1) Taste zur Erhöhung des Wertes
- 2) Taste zum Verringern des Wertes
- 3) Taste Menü/Esc
- 4) Taste Cal/OK
- 5) Taste zum Einstellen des Sollwerts
- 6) Digitalanzeige

Programm-Einstellung - 5 Sekunden lang gedrückt halten

Bei der Eingabe jedes Menüpunktes kann der Parameter direkt mit den Pfeiltasten geändert werden (und .

Die Bestätigung der aktuellen Einstellung und das Umschalten zum nächsten Punkt erfolgen durch Drücken der Taste .

Das Menü ist kreisförmig aufgebaut: Wenn Sie den letzten Punkt erreicht haben, bestimmt die Bestätigung der Parametereinstellung durch Drücken von die Rückkehr zum ersten Menüpunkt.

- 1 **SPRACHE:** Es stehen fünf Sprachen zur Verfügung, aus denen gewählt werden kann: **EN**, FR, IT, DE, ES
- 2 **PH**

- SOLLWERT: **7,2pH** (6-8pH)
- SOLLWERT TYP: **Säure** (Sauer/Alka)
- ZEIT_AN = 30 Sekunden (Bereich von 1 bis 360 Sekunden)
- ZEIT_AUS = 60 Sekunden (Bereich von 1 bis 360 Sekunden)
- TEMPERATUR: 25°C; Stellen Sie °C/°F und den manuellen Wert ein
- OFA ALARM Aus, 1-60' (Minuten)

* Nur zeitgesteuerte Dosierung

3 ORP

- SOLLWERT: **700 mV** (400-850mV)
- SOLLWERT TYP: **Niedrig** (Niedrig/Hoch)
- ZEIT_AN = 30 Sekunden (Bereich von 1 bis 360 Sekunden)
- ZEIT_AUS = 60 Sekunden (Bereich von 1 bis 360 Sekunden)
- OFA ALARM Aus, 1-60' (Minuten)
- **Hinweis:** Die Redox-Dosierung in Gegenwart von Chlor hat keinen Einfluss auf die Dosierpumpe. Es kann das Aux2-Relais mit EIN/AUS-Aktivierung in Bezug auf den Sollwert handhaben.

* Nur zeitgesteuerte Dosierung

4 CHLOR

- SOLLWERT: **1,2 ppm**(0,3-3,0 ppm)
- SOLLWERT TYP: **Niedrig** (Niedrig/Hoch)
- ZEIT_AN = 30 Sekunden (Bereich von 1 bis 360 Sekunden)
- ZEIT_AUS = 60 Sekunden (Bereich von 1 bis 360 Sekunden)
- OFA ALARM Aus, 1-60' (Minuten)

* Nur zeitgesteuerte Dosierung

5 ERWEITERTES MENÜ

- FILTERPUMPE: (aktiviert/deaktiviert)
- FREQUENZ
 - AN-AUS
 - Impuls/L 1:1
 - Geraet: L, m³

- KALIB. PH: 2 Punkte, 1 Punkt, Referenz, Deaktivieren
 - KALIB. ORP: 1 Punkt, Referenz, Deaktivieren
 - KALIB. CL: 2 Punkte, Deaktivieren
 - KALIB. TEMP: Referenz, Deaktivieren
1. **Dosierart pH:** Proportional, OFF, CYCLE, Timed, On/OFF
 1. **Hinweis:** Zyklus-Dosierungsmodus, es ist nur in der PoolDose SPA-Anwendung vorhanden.
 2. **Dosierart ORP:** Proportional, OFF, **CYCLE**, Timed, On/OFF,
 1. **Hinweis:** Die Redox-Dosierung ist deaktiviert, wenn **der Dosiertyp Chlor** anders ist als AUS
 1. **Hinweis:** Zyklusdosiermodus, nur in der PoolDose SPA-Anwendung vorhanden.
- DOSIERUNGSTYP CHLOR: Prop, Aus, Zeitgesteuert, An/Aus
 - AUX RELAIS
 - AUX1 RELAIS: pH, Deaktivieren
 - AUX2 RELAIS: Chlor, ORP, Deaktivieren
 - **Hinweis:** Aux1- und Aux2-Relais dosieren mit EIN/AUS-Methode
 - PASSWORD: 0000 (**Hinweis:** Passwort deaktiviert; einen anderen Wert einstellen als: 0000)
 - RESET CAL: (**Hinweis:** Wählen Sie die Maßnahme zum Zurücksetzen: pH; Chlor; ORP)
 - RESET PARAMETE: STANDARDPARAMETER ZURUCKSETZEN
 - SYSTEMSTEUERUNG: Zeigt die elektrischen Signale an
 - WIFI-KONFIGURATION
 - WIFI-Netzwerkname
 - WIFI Passwort
 - WIFI-Netzwerk-IP-Adresse.
- Hinweis:** Dieses Menü ist nur im WiFi-Produkt verfügbar, es ist in der PoolDose SPA-Anwendung nicht vorhanden.
- REED (Anzeigefehler, wenn Rot): NO/NC
 - P.ON VERZOEGERUNG: Deaktiviert die Dosierpumpen für die eingestellte Zeit (OFF...1:90 Minuten)
 - DURCHF. VERZOEG.: Deaktiviert die Dosierpumpen für die eingestellte Zeit (OFF...1:60 Minuten)

Hinweis: Timeout-Einstellungsmenü - Nach 120 Sekunden ohne Aktion wird der Controller ohne Speichern von Parametern beendet.

Anzeigebeispiel

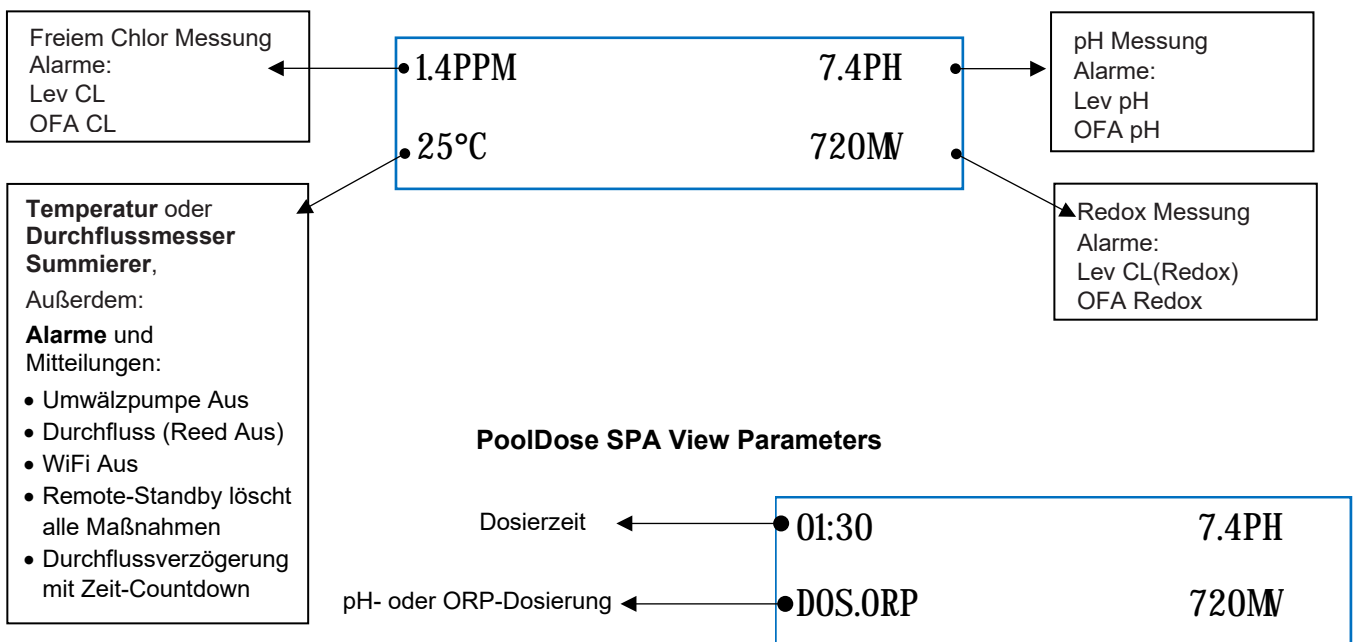









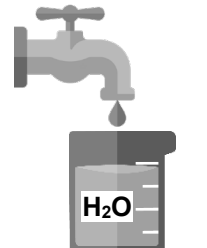

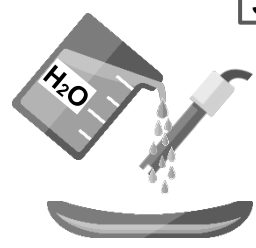
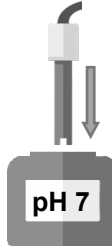



PoolDose | pH · ORP · Chlor

Kalibrierungsmenü

Die **enter cal**-Taste 3 Sekunden lang drücken und kalibrieren Sie die pH-Sonde, die Redox-Sonde, die Chlorsonde oder die Temperatur.

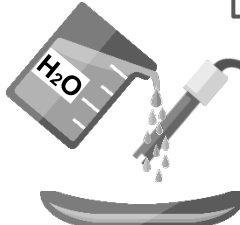
7. pH-KALIBRIERUNG

 <p>1</p>	 <p>2</p>	 <p>3</p>	 <p>4</p>
 <p>5 s</p> <p>pH kalibrieren</p>	 <p>pH 7-Kalibrierung</p>	 <p>90 s</p>	 <p>8</p>
 <p>9</p>	 <p>10</p>	 <p>pH 4-Kalibrierung</p>	 <p>90 s</p>
 <p>13</p>	 <p>14</p>	 <p>15</p>	 <p>Speichern und verlassen</p>

Hinweis: Wenn die Funktion „1 Punkt Kal.“ eingestellt wurde, wird nur an einem (1) Punkt kalibriert, und zwar mithilfe der Pufferlösung pH 7.

Referenzkalibrierung

Referenz KAL
7.2 pH

Das Gerät blinkt einen pH
Stellen Sie mit dem
Instrument gemessen
Ex. 7.4 pH

Referenz KAL
7.4 pH





8. REDOX-KALIBRIERUNG

 <p>1</p>	 <p>2</p>	 <p>3</p>	 <p>4</p>
 <p>5</p> <p>enter cal 5 s</p> <p>Redox-Kalibrierung aufrufen</p>	 <p>6</p> <p>enter cal</p> <p>465 mV-Kalibrierung</p>	 <p>7</p> <p>90 s</p>	 <p>8</p> <p>465 mV Quality probe 100%</p>
 <p>9</p>	 <p>10</p>	 <p>11</p> <p>enter cal</p> <p>Speichern und verlassen</p>	

Referenzkalibrierung

<p>Referenz KAL 720 mV</p> <p>Das Gerät blinkt einen Redox Stellen Sie mit dem Instrument gemessen Ex. 750 mV</p>	<p>Referenz KAL 750 mV</p>  <p>enter cal</p>
---	---

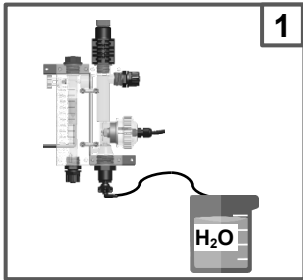
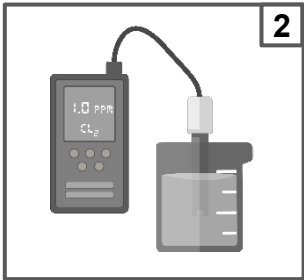
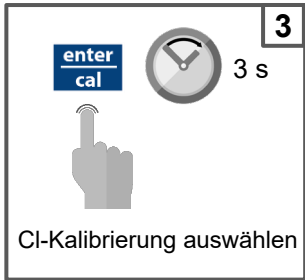
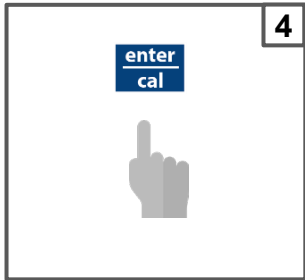
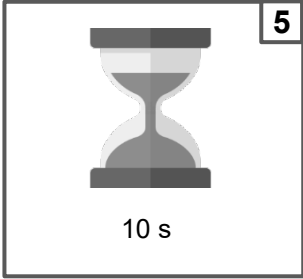
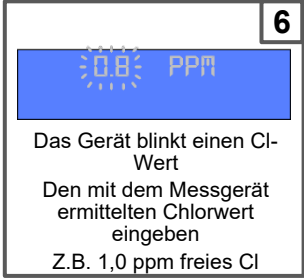
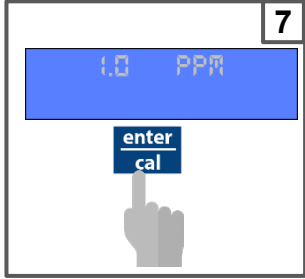
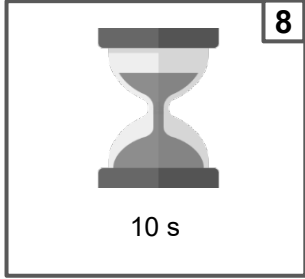
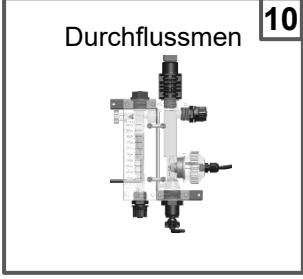
9. CHLOR-KALIBRIERUNG

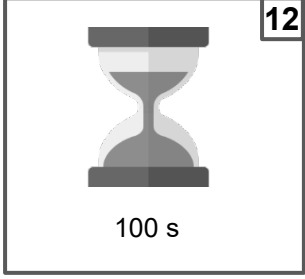
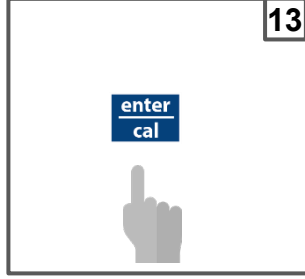
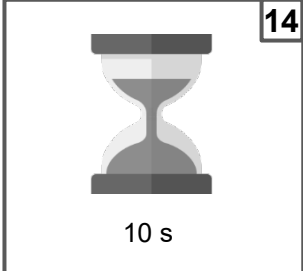
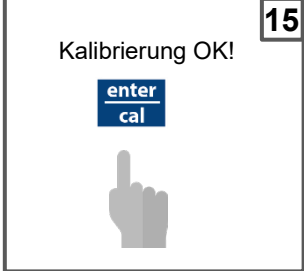
 <p>1</p>	 <p>2</p>	 <p>3</p> <p>Cl-Kalibrierung auswählen</p>	 <p>4</p>
 <p>5</p> <p>10 s</p>	 <p>6</p> <p>Das Gerät blinkt einen Cl-Wert Den mit dem Messgerät ermittelten Chlorwert eingeben Z.B. 1,0 ppm freies Cl</p>	 <p>7</p>	 <p>8</p> <p>10 s</p>
 <p>10</p> <p>Durchflussmen</p>	 <p>11</p> <p>Bestätigen Sie, dass der F geschlossen ist, indem Sie die Auswahl auf Ja verschieben und mit CAL . bestätigen</p>	 <p>12</p> <p>100 s</p>	 <p>13</p>
 <p>14</p> <p>10 s</p>	 <p>15</p> <p>Kalibrierung OK!</p>		

* Drücken Sie ESC, um das Kalibrierungsmenü zu verlassen.

10. TEMPERATURKALIBRIERUNG

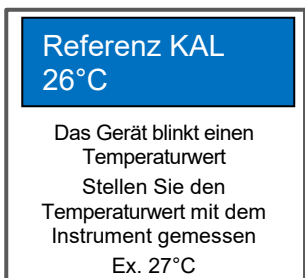
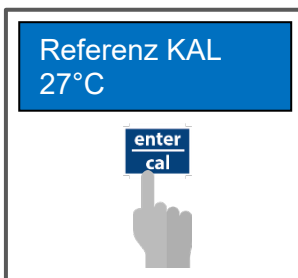
 <p>10</p> <p>Das Gerät blinkt einen Temperaturwert Stellen Sie den Temperaturwert mit dem Instrument gemessen Ex. 27°C</p>	 <p>11</p>
---	--

PoolDose | pH · ORP · Chlor

Sollwerteinstellung

Die **set**-Taste 3 Sekunden lang drücken, **▲** und **▼** verwenden, um den gewünschten Wert einzustellen.



Kalibrierungsmenü

Die **enter cal**-Taste 3 Sekunden lang drücken und kalibrieren Sie die pH-Sonde, die Redox-Sonde, die Chlorsonde oder die Temperatur.

Standby-Modus (Hintergrundbeleuchtung an)

Die Tasten **▲** und **▼** gleichzeitig 5 Sekunden lang drücken, um die Hintergrundbeleuchtung des Geräts auszuschalten. Dosierung und Kalibrierung sind deaktiviert.

OFA-Reset

Drücken Sie **menu esc** (3 Sekunden), um den OFA-Alarm zurückzusetzen oder drücken Sie die Tasten **▲** und **▼** gleichzeitig (5 Sekunden), um den OFA-Alarm zurückzusetzen.

Pumpe ansaugen

Nur während sich die Pumpe im Standby-Modus befindet, drücken Sie **▲** um den Durchflusszähler zurückzusetzen, drücken Sie **▼** um die pH-Pumpe zu betreiben, drücken Sie **menu esc** um die Redox-/Chlorpumpe zu betreiben, drücken Sie **enter cal** um das Aux1-Relais zu betreiben, drücken Sie **set** um das Aux2-Relais zu betreiben.

PoolDose SPA Dosierung

Die Regulierung von pH und Chlor im PoolDose Spa-System wird verwaltet, indem die pH-Regulierung vor der Chlordosierung gehalten wird, um eine bessere Regulierung zu erzielen. Diese Funktion ist nur bei PoolDose SPA-Produkten verfügbar.

Um zur Standardeinstellung zurückzukehren, wie folgt vorgehen:

- Die PoolDose -Einheit ausschalten
- **▲** und **▼** gedrückt halten und Strom wieder einschalten
- Das Gerät zeigt **INIT.DEFAULT**
- Wählen Sie die zurückzusetzende Einheit aus – WLAN-Modul oder Dosiersystem
- Drücken Sie **▲** oder **▼** drücken um **JA** oder **NEIN** auszuwählen
- Wählen Sie **JA** und drücken Sie **enter cal**, um die Standardparameter wiederherzustellen.

Standardeinstellwerte:

- Sprache = **EN**
- Sollwert = **pH 7,2; 700 mV (Redox); 1,2 ppm (Cl)**
- Zugabeverfahren = **pH Senken (pH), Niedrig (Redox), Niedrig (Cl)**
- OFA-Zeit = **Aus**
- Kalibrierung = **Voll**
- Durchflusseingang = **AUS (Filterpumpe)**
- Zugabeart = **PROP; AN-AUS Relais Aux1 und Aux2**
- IN-Frequenz. = **AUS**
- Reed = **NC (normalerweise geschlossen)**
- P.ON (Einschaltverzögerung) = **Aus**
- Durchflussverzögerung = **Aus**

11. DOSIERUNGSMETHODE

Sollwert = 7,2 pH

Dosiermodus = pH Senken

Proportionalband = 1,0 pH (*nicht veränderbarer Wert)

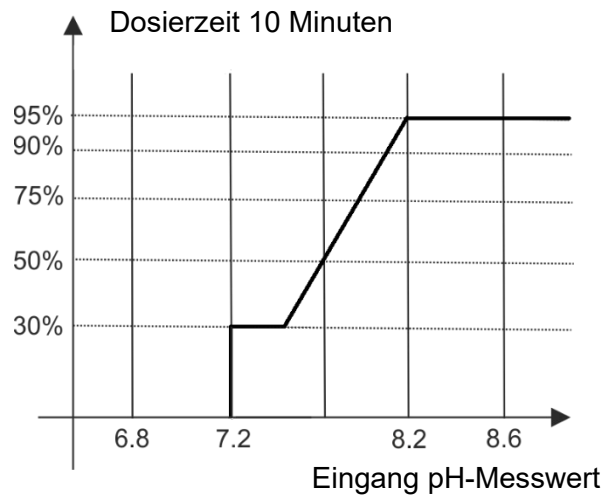

Sollwert = 700 mV

Dosiermodus = Niedrig

Proportionalband = 250 mV (*nicht veränderbarer Wert)

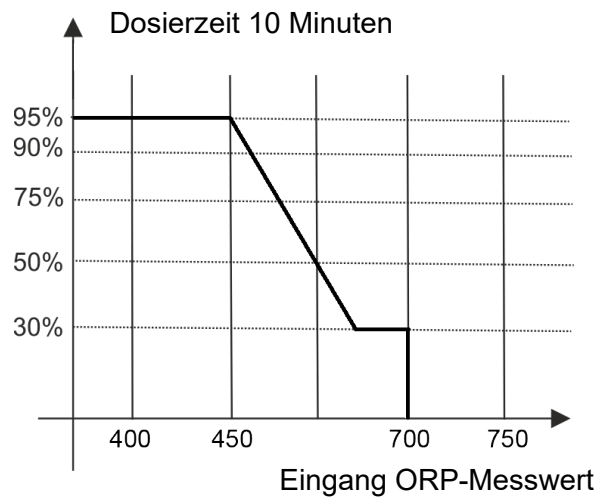

Sollwert = 1,2ppm freies Chlor

Dosiermodus = Niedrig

Proportionalband: 0,8ppm (*nicht veränderbarer Wert)

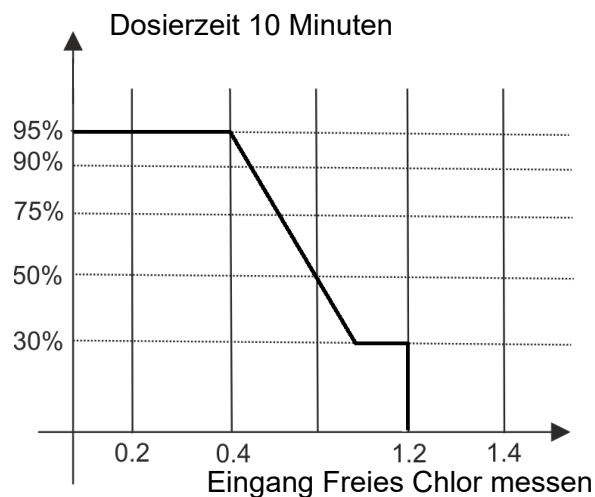

12. ZYKLUS-DOSING-METHODE

Die Zyklusdosiermethode ist nur im PoolDose SPA-Modell verfügbar

Die Zyklen sollten wie folgt sein:

- 20 Minuten Wartezeit

- 4 min Dosierzyklus in Dosierung für pH-Dosierung (wenn der pH-Wert keine Dosierung erfordert, wird die

- System kann Dosierung für Rx bei Bedarf verwalten) (Priorität auf pH)

- 20 Minuten Wartezeit

- 4 min Dosierzyklus in Dosierung für pH-Dosierung (wenn der pH-Wert keine Dosierung erfordert, wird die

- System kann Dosierung für Rx bei Bedarf verwalten) (Priorität auf pH)

Exct.

Proportional bedeutet:

Der Zeitrahmen beträgt 60 Sekunden:

Da der Messwert bei 90 % des Sollwertes liegt, beträgt die Betriebszeit 14 Sekunden

Da der Messwert bei 75 % des Sollwertes liegt, beträgt die Betriebszeit 20 Sekunden

Da der Messwert bei 50 % des Sollwertes liegt, beträgt die Betriebszeit 30 Sekunden



Da der Messwert bei 25 % des Sollwertes liegt, beträgt die Betriebszeit 40 Sekunden

Alarm für die pH/Redox-Einstellung

Wenn ein Alarmbereich eingestellt ist, wird ein Arbeitsfenster erzeugt. Wenn die zulässigen Grenzwerte überschritten werden, schließt das Alarmrelais und bleibt so lange geschlossen, bis der Messwert zurückgesetzt ist oder  gedrückt wird, um den Alarm abzuschalten.

Wenn eine OFA-Zeit (Over Feed Alarm) eingestellt ist, wird die Zugabezeit der pH-/Redox-Einstellung durch zwei Alarme gesteuert:

- Der erste Alarm erscheint bei 70 % der eingestellten Zeit im Display, das Alarmrelais schließt.
- Der zweite Alarm erscheint bei 100 % der eingestellten Zeit im Display, das Alarmrelais schließt und die pH-/Redox-Pumpe wird gesperrt.

Drücken Sie  (3 Sekunden), um den OFA-Alarm zurückzusetzen oder drücken Sie die Tasten  und  gleichzeitig (5 Sekunden), um den OFA-Alarm zurückzusetzen.

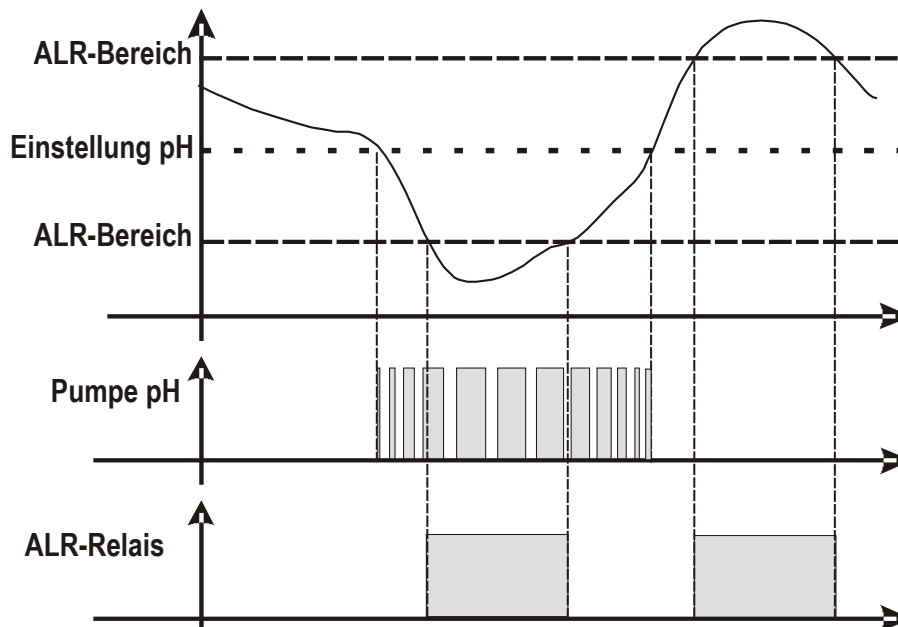

(*1 Messen Alarmbereiche - Festwerte)

n	Item	Grenzen
1	Temp.- Messung min	+ 10°C
2	Temp.- Messung Max	+ 38°C
3	pH-Messung min	6 pH
4	pH- Messung Max	8 pH
5	ORP- Messung min	+ 600 mV
6	ORP- Messung Max	+ 800 mV
7	CL- Messung min	0,50 ppm
8	CL- Messung Max	2 ppm

12. INTERNER WEBSERVER

Herunterladen **SekoLink** Anwendung

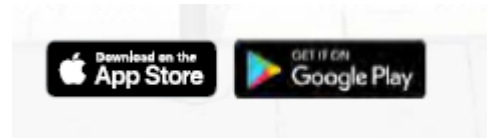

Registrierte dein Konto

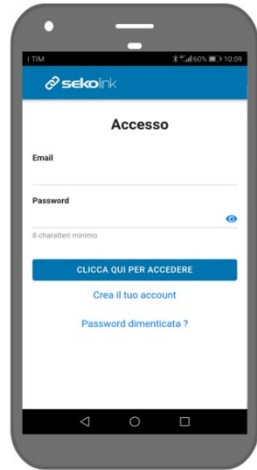

Mit Hilfe der QrCode, loggen Sie sich in den internen Web-Seiten Set:

User name= ADMIN
Password= 0000



Stellen Sie Ihr WiFi-LAN Name und Passwort ein und bestätigen.

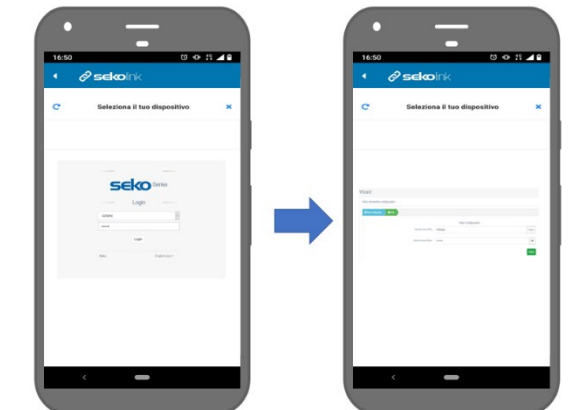

Füllen Sie das Geräteregistrierung

Dank Ihrer Registrierung können Sie **sekolink** und **sekoweb** kostenlos nutzen.



sekolink

Dank der **sekolink** APP Sie Ihren Pool steuern:

- Überwachung und begrenzte Verwaltung
- Smartphone-App kompatibel mit iPhone oder Android
- Für Endbenutzer









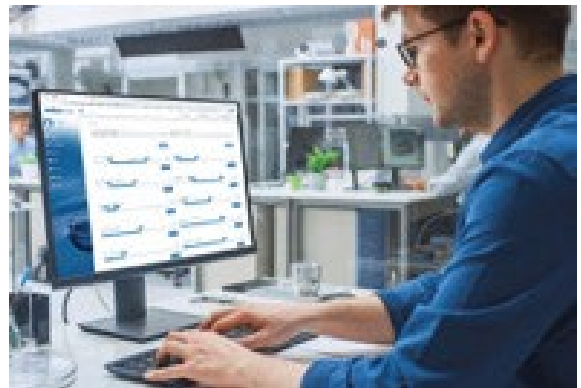



sekoweb

Verwenden Sie die **sekoweb**-Adresse www.sekoweb.com oder die APP, um Ihre Pools mit einem professionellen Webportal zu verwalten:

- Überwachung und vollständige Verwaltung
- Internetportal zugänglich über Online-Anmeldung oder durch Scannen eines QR-Code des Produkts
- Für Pool- und Spa-Installateure, Techniker und Ingenieure



13. ALARME

Alarmer	Display	Maßnahmen
Stufe *nur aktive Maßnahmen	FUELLSTAND	- Zum Öffnen des Alarmrelais  drücken - Produktbehälter zurücksetzen/auffüllen
Messung außerhalb des Arbeitsbereichs	ALARMBAND	- Den Messfühler prüfen, ggf. ersetzen - Zum Öffnen des Alarmrelais  drücken - Messung wiederholen
Erste OFA-Alarmstufe (Zeit >70%)	OFA_1	- Zum Zurücksetzen 3 Sekunden lang  drücken oder 5 Sekunden lang   drücken, um zurückzusetzen
Zweite OFA-Alarmstufe (Zeit 100%)	OFA_2	- Zum Zurücksetzen 3 Sekunden lang  drücken oder 5 Sekunden lang   drücken, um zurückzusetzen
Durchfluss	FLOW	- Durchfluss wiederherstellen
Kalibrierfunktion	KALIBRIERFEHLER	- Sonde oder Pufferlösung ersetzen und neu kalibrieren
Stufe	PARAMETER FEHLER	-  drücken, um zur Standardeinstellung zurückzukehren - Gerät defekt
Alarm Messungen (*1)	MESSUNG ZU NIEDRIG MESSUNG ZU HOCH	- Passen Sie die chemische Konzentration an
Das WLAN-Menü ist im erweiterten Menü nicht vorhanden, aber die WLAN-Karte ist vorhanden	WIFI-MENU IST NICHT VORHANDEN	- Gerät ausschalten, gedrückt halten  und einschalten.
Fehlermessung	FALSCHES MAß	- Bitte setzen Sie den Kalibrierungsparameter zurück, klicken Sie in Advanced Menu auf <u>Reset CAL Item</u> .

(*1 Messen Alarmbereiche)

n	Item	Grenzen
1	Temp.- Messung min	+ 10°C
2	Temp.- Messung Max	+ 38°C
3	pH-Messung min	6 pH
4	pH- Messung Max	8 pH
5	ORP- Messung min	+ 600 mV
6	ORP- Messung Max	+ 800 mV
7	CL- Messung min	0,50 ppm
8	CL- Messung Max	2 ppm

14. HANDHABUNG

Ersetzen der Schläuche

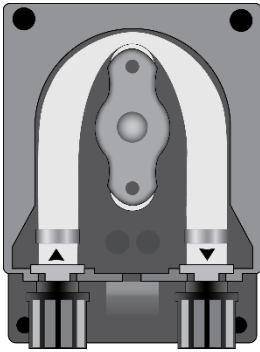

Den Pumpendeckel öffnen und den Schlauch durch Hochziehen des linken Anschlusses freigeben.

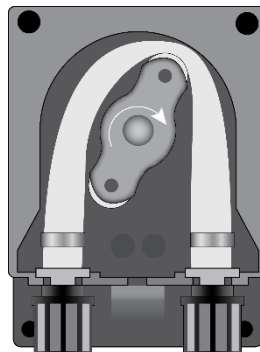

Den Rotor auf „7:05 Uhr“ stellen, dazu in Richtung des kreisförmigen Pfeils drehen.

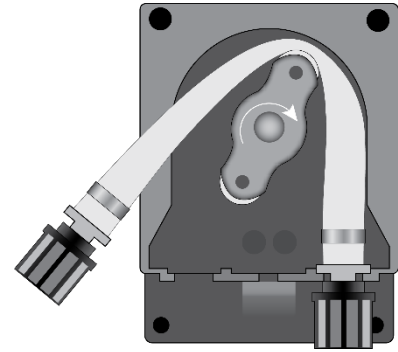

Den linken Anschluss vollständig freigegeben und dabei leicht nach außen ziehen. Den Läufer in Richtung des kreisförmigen Pfeils drehen, so dass der Schlauch am rechten Anschluss freigegeben wird

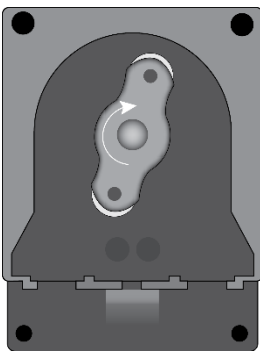

Den Rotor auf „7:05 Uhr“ stellen, dazu in Richtung des kreisförmigen Pfeils drehen.

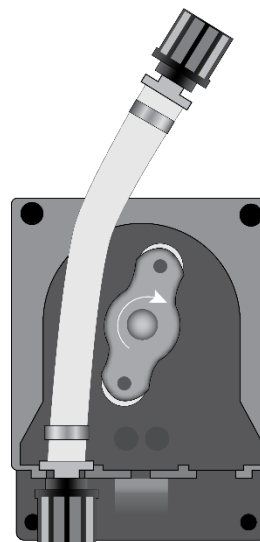

Den linken Anschluss in sein Gehäuse schieben und den Schlauch unter der Rotorführung durchschieben. Den Rotor in Richtung des kreisförmigen Pfeils drehen und dabei gleichzeitig den Schlauch in den Pumpenkopf einführen, bis der rechte Anschluss erreicht wird.

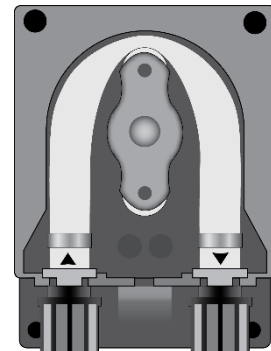

Den Pumpendeckel schließen und fest darauf drücken, so dass er richtig einrastet.

*Verfahren zum Austauschen des Schlauchs gültig für 2 und 3 Walzen.

15. LAGERUNG DER PUMPE NACH GEBRAUCH

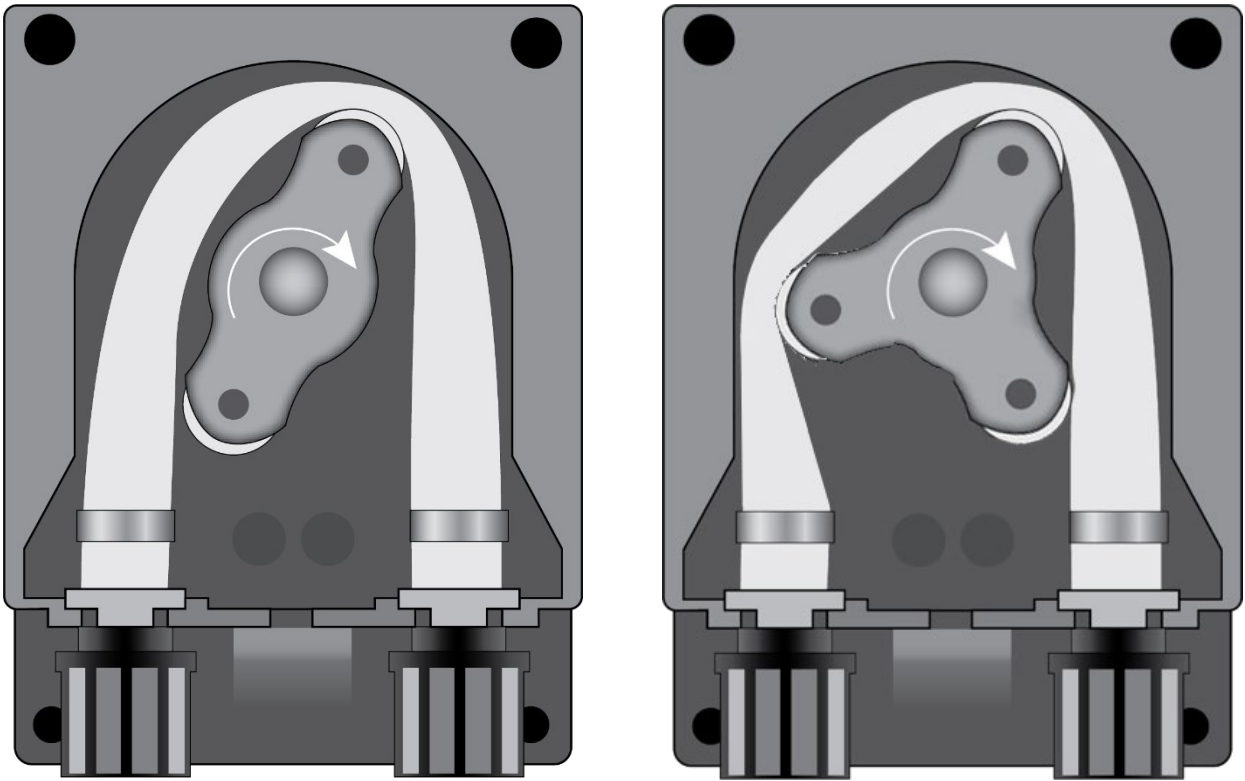

Wenn das Regelgerät außer Betrieb genommen wird, ist der Schlauch mit klarem Wasser zu spülen.

Den Rotor auf „7:05h“ stellen, dazu in Richtung des kreisförmigen Pfeils drehen.

Diese beiden Vorbeugemaßnahmen erleichtern die spätere Wiederinbetriebnahme.

PoolDose | pH · ORP · Chlor

Kabelverbindungen:

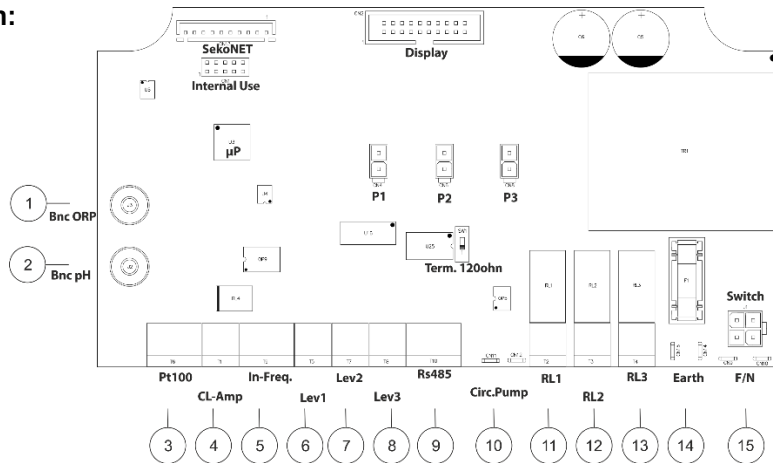

Beschrifteten Verbindungen:

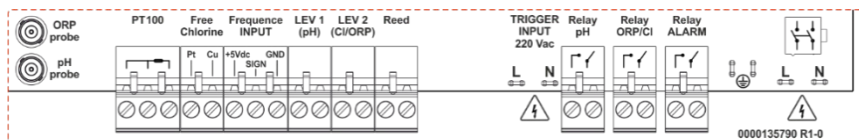

Klemme	Beschreibung	PoolDose pH · ORP	
1	Einlasssonde	ORP	Redox-Sonde
2	Einlasssonde	pH	pH-Sonde
3	Einlasssonde	Temperatursensoreingang (PT100): A: Temperaturfühler mit zwei Drähten B: Temperaturfühler mit drei Drähten	
4	Eingang freies Chlor-Sensor	Eingang freies Chlor-Sensor: Pt: Platin Sensor Cu: Kupfer Sensor	
5	Eingangsfrequenz Signal	Frequenzsignaleingang für Wasserzähler A: Mechanischer Wasserzähler mit Reedsensor B: Padwheel Wasserzähler mit Hallsensor	
6	Füllstand	pH Füllstandssonde	Produktbehälter Füllstandssonde
7	Füllstand	Chlor (ORP) Füllstandssonde	Produktbehälter Füllstandssonde
8	Füllstand	Durchfluss (REED Sensor)	Durchflusssensor
9	Serielle Schnittstelle	Nicht vorhanden	Keiner
10	Triggereingang	Umwälzpumpe (Eingang 220Vac)	Fase / Neutral-Drähte
11	Ausgangsrelais	RL1 AUX1 pH	Trockenkontakt
12	Ausgangsrelais	RL2 AUX2 ORP/Chlor	Trockenkontakt
13	Ausgangsrelais	RL3 Alarme	Trockenkontakt
14	Erdungsanschluss	Erdung	---
15	Stromversorgung	220-240 Vac 50-60 Hz (F/N)	---



¡ADVERTENCIA!

Antes de llevar a cabo CUALQUIER TIPO de trabajo en el interior del panel de control del dispositivo PoolDose, asegúrese de desconectarlo de la fuente de alimentación.

El incumplimiento de las instrucciones recogidas en el presente manual puede ocasionar lesiones a las personas y/o daños al aparato y al sistema.

1. CONTENIDO DEL EMBALAJE

A: manguera de succión PVC cristal de 4x6 (4 m)	B: manguera de suministro de polietileno (5 m)	C: Válvula de labio FPM (3/8" GAS)	D: soporte de sonda PSS3 (1/2" GAS)	E: montura de conexión para asegurar PSS3 en la manguera 2" (φ=50 mm)	F: Reductor para válvula de inyección (1/2" M hasta 3/8" F)
G: Filtro de fondo (elevador de PP)	H: kit del soporte de montaje (φ= tornillos 6 mm)	L: Sensor de temperatura	M: sonda de pH	N: Sonda Redox	O: soporte de sondas + sonda de cloro
P: filtro menor (5") + soporte de sonda PSS3 (1/2" GAS)	Q: cepillo de limpieza para sonda de cloro	R: bolitas para sonda de cloro	S: solución tampón pH 4	T: solución tampón pH 7	U: Solución de calibración 465 mv
V: Agua					

Elemento *	Sistema	Sistema de bomba doble	
		PoolDose pH / ORP	PoolDose pH / ORP / CL
A		2	2
B		2	2
C		2	2
D		2	-
E		4 ^(*1)	4 ^(*1)
F		2	2
G		2	2
H		1	1
L		1 ^(*2)	1 ^(*2)
M		1	1
N		1	1
O		-	1
P		-	1
Q		-	1
R		-	1
S		1	1
T		1	1
U		1	1
V		1	1

* Los valores de la tabla representan el número de elementos que vienen dentro del paquete.

(*1 Cinco piezas solo para el modelo WiFi)

(*2 Una pieza solo para el modelo WiFi)

¡ADVERTENCIA!

Estos productos son **PELIGROSOS (I✳A)** y requieren precauciones especiales durante su uso, manejo y almacenamiento.

- **No mezcle NUNCA productos químicos.**
- No permita NUNCA que niños o personas que no hayan leído este manual usen o manipulen PoolDose o alguno de sus componentes periféricos (incluidos los productos químicos).

Productos químicos de pH:

- No recomendado **EN ABSOLUTO** => ácido sulfúrico puro
- Recomendado para reducir el pH => pH negativo (con una base de ácido sulfúrico)
- Recomendado para aumentar el pH => pH positivo (carbonato de sodio o bicarbonato)

Productos químicos Redox:

- No recomendado **EN ABSOLUTO** => cualquier tipo de cloro orgánico
- Puede usarse cloro líquido o lejía de 12% puros. Si el producto tiene una concentración de 48%, es necesario diluirlo en agua en una proporción de 1:3.

Las sondas de pH/Redox están sujetas a desgaste y al deterioro, por lo que no están cubiertas por la garantía.

2. INSTRUCCIONES DE INSTALACIÓN

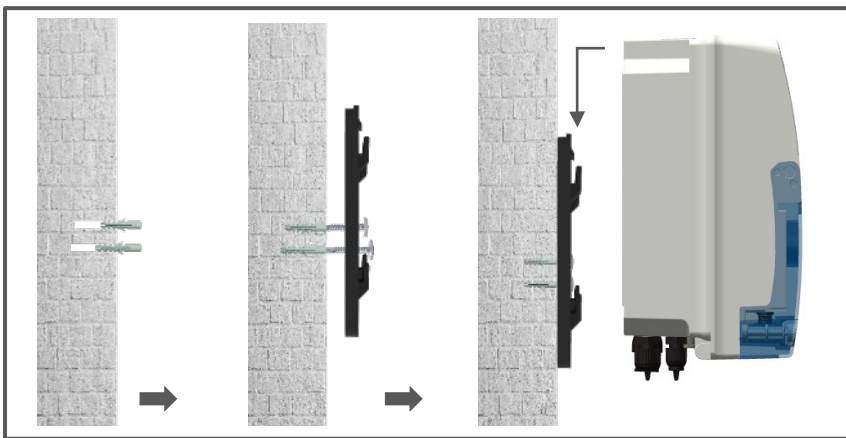

Asegúrese de que la presión de inyección está por debajo de 1,5 bar.

Colocación de la sonda



Para una lectura óptima de la sonda, colóquela en perpendicular a la tubería.



El ángulo de inclinación de la sonda nunca debe sobrepasar los 45° de



Planta de instalación

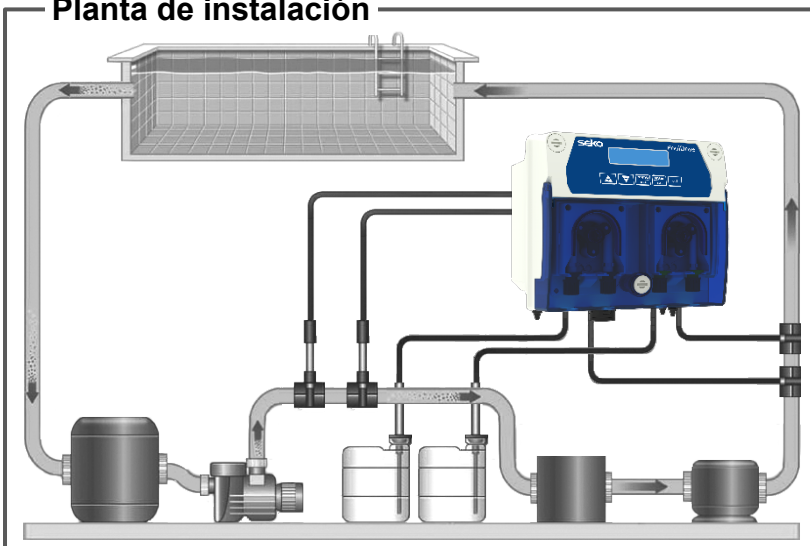

¡Advertencia!

Usar con clorador salino:

En los sistemas de pH, para evitar el riesgo de que el sistema funcione incorrectamente o se dañe, respete las siguientes instrucciones:

1. Coloque la sonda de medición de pH antes de la célula del clorador.
2. Para eliminar las corrientes parásitas, conecte el agua de la piscina a un punto eléctrico de tierra.
3. Coloque el punto de inyección de producto tras la célula del clorador.

3. CONEXIONES ELÉCTRICAS

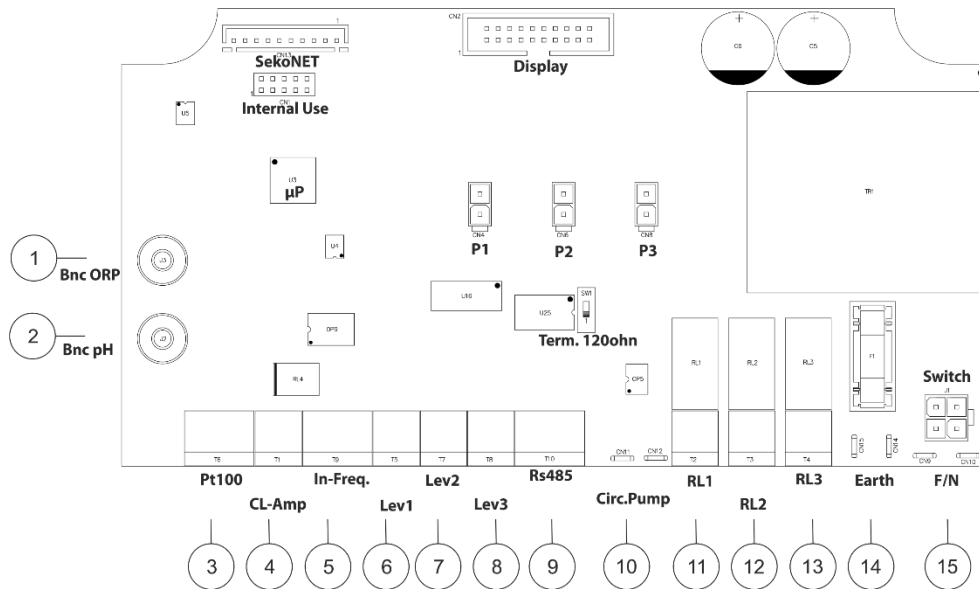

Abrazadera	Descripción	Sistema de bomba doble	
		PoolDose pH · ORP	PoolDose pH · ORP · CL
1	Entrada de sonda	ORP	ORP
2	Entrada de sonda	pH	pH
3	Entrada de sonda	TEMP (PT100)	TEMP (PT100)
4	Entrada de sonda	No utilizado	Cloro libre
5	Entrada de señal de frecuencia	Caudal (Entrada frec.)	Caudal (Entrada frec.)
6	Nivel (tanque de producto)	Sonda de nivel pH	Sonda de nivel pH
7	Nivel (tanque de producto)	Sonda de nivel Cloro (ORP)	Sonda de nivel Cloro
8	Nivel (sensor de flujo Reed externo)	Flujo (sensor REED)	Flujo (sensor REED)
9	Puerto serial	No presente	No presente
10	Entrada de disparo 220Vac (alto voltaje)	Bomba de recirculación (Entrada 220Vac)	Bomba de recirculación (Entrada 220Vac)
11	Salida de relé R1	RL1 AUX1 pH	RL1 AUX1 pH
12	Salida de relé R2	RL2 AUX2 OPR/ Cloro	RL2 AUX2 OPR/ Cloro
13	Salida de relé R3	RL3 Alarma	RL3 Alarma
14	Conector de tierra	Tierra	Tierra
15	Fuente de alimentación	220-240 Vac 50-60 Hz (F/N)	220-240 Vac 50-60 Hz (F/N)
P1	Conexión de bomba peristáltica	pH	pH
P2	Conexión de bomba peristáltica	Cloro (ORP)	Cloro
P3	Conexión de bomba peristáltica	No utilizado	No utilizado
SekoNet	Módulo WiFi	Tarjeta WiFi (código dedicado)	Tarjeta WiFi (código dedicado)

Etiqueta de conexiones

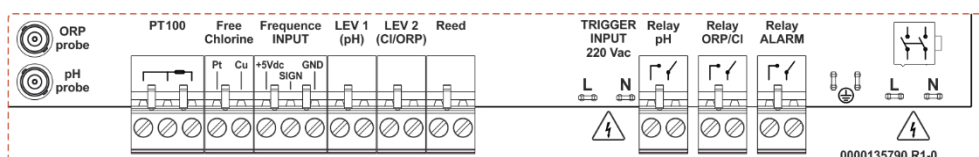

4. ESPECIFICACIONES TÉCNICAS

Especificaciones	PoolDose Double pH/ORP	PoolDose Double pH/ORP/Cloro
Dimensiones (A-L-P)	A:194,5 x L:205,1 x P:132,8 mm	A:194,5 x L:205,1 x P:132,8 mm
Peso	3,5 Kg	3,5 Kg
Estado de la bomba	Pausa - Suministro	Pausa - Suministro
Calibración de sonda	Automático	Automático
Fuente de alimentación	220-240 VAC 50-60 Hz	220-240 VAC 50-60 Hz
Consumo (W)	28 Watt	28 Watt
Precisión del dispositivo	± 0,1 pH; ±10mV; ±1°C	± 0,1 pH; ±10mV; 0,1 ppm; ±1°C
Exactitud	±0,02pH, ±3mV; ±0,5°C	±0,02pH, ±3mV; 0,05 ppm; ±0,5°C
Rango	0-14pH; -99 -1000mV; 0...+55°C	0-14pH; -99 -1000mV; 0-5 ppm; 0...+55°C
Caudal de la bomba (l/h)	1,5 l/h	1,5 l/h
Caudal de la bomba (solo modelo SPA)	0.4 l/h	Indisponible
Contrapresión máx.	1,5bar	1,5bar
Contacto de relé (número 3)	250 Vac 10A (carga resistiva)	250 Vac 10A (carga resistiva)
Fusible	500 mA (rápido)	500 mA (rápido)

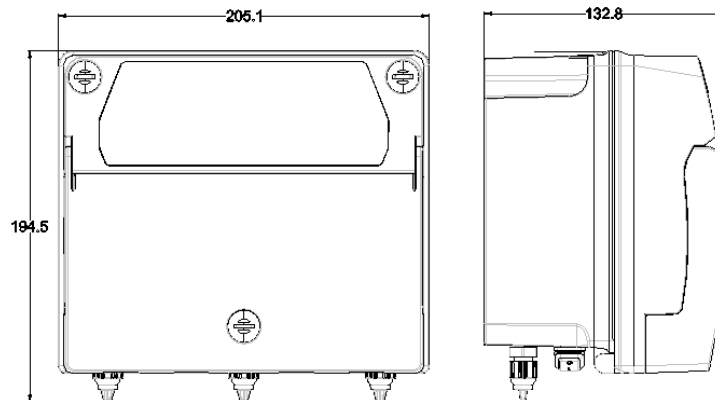

5. DISPOSITIVO SUPRESOR ELÉCTRICO

Es obligatorio instalar el supresor de bobina por favor debajo del procedimiento de instrucciones:

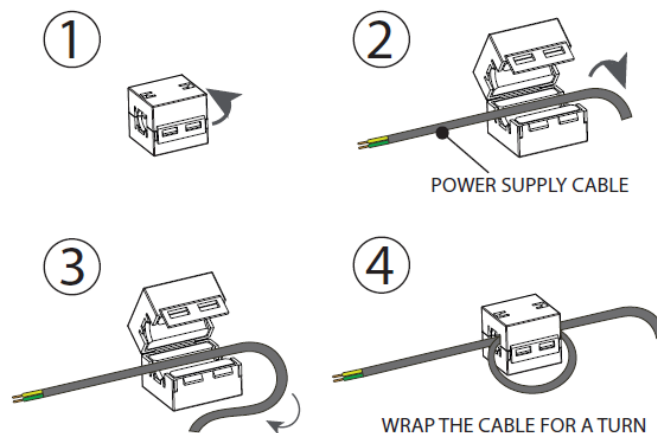

6. INSTRUCCIONES DE CONFIGURACIÓN DEL SISTEMA

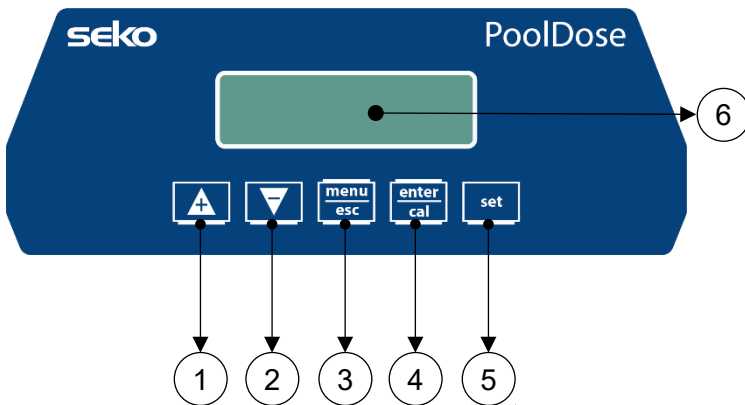

- 1) Botón para aumentar el valor
- 2) Botón para reducir el valor
- 3) Botón Menú/Esc
- 4) Botón Cal/OK
- 5) Botón para configurar el punto de ajuste
- 6) Pantalla digital

Configuración del programa – Pulse **menu esc** durante 5 segundos

En la entrada de cada elemento del menú, el parámetro puede ser modificado directamente utilizando las teclas de flecha (**▲** y **▼**). Para confirmar el ajuste actual y pasar al siguiente elemento, pulse el botón **enter cal**.

El menú tiene una estructura circular: una vez en el último elemento, la confirmación del parámetro configurado se realiza pulsando **enter cal**, y provoca el regreso al primer elemento del menú.

1 IDIOMA – Se puede seleccionar entre 5 idiomas disponibles: **EN**, **FR**, **IT**, **DE**, **ES**

2 PH

- SETPOINT – **7,2pH** (6-8pH)
- TIPO SETPOINT: – **Ácido** (Ácido/Alka)
- TIEMPO ON = 30 segundos (rango desde 1 a 360 segundos)
- TIEMPO OFF = 60 segundos (rango desde 1 a 360 segundos)
- TEMPERATURA: 25°C; impostare °C/°F e valore manuale
- ALARMA OFA: Off, 1-60' (minudos)

* Solo dosificación programada

3 ORP

- SETPOINT – **700 mV** (400-850mV)
- TIPO SETPOINT: **Bajo** (Bajo/Alto)
- TIEMPO ON = 30 segundos (rango desde 1 a 360 segundos)
- TIEMPO OFF = 60 segundos (rango desde 1 a 360 segundos)
- ALARMA OFA: Off, 1-60' (minudos)
- **Nota:** La dosificación de ORP (redox) en presencia de cloro no tiene efecto sobre la bomba dosificadora, pero puede gestionar el Relé Aux2 con activación ON/OFF con respecto al Setpoint.

* Solo dosificación programada

4 CLORO

- SETPOINT – **1,2 ppm**(0,3-3,0 ppm)
- TIPO SETPOINT: **Bajo** (Bajo/Alto)
- TIEMPO ON = 30 segundos (rango desde 1 a 360 segundos)
- TIEMPO OFF = 60 segundos (rango desde 1 a 360 segundos)
- ALARMA OFA: Off, 1-60' (minudos)

* Solo dosificación programada

5 MENU AVANZADO

- BOMBA DE CIRCULACION – (Activada/desactivada)
- EN FREC (Entrada caudal)
 - OFF/ON
 - Impulso/Litro:1 o Litro/Impulso:1 – Impostare valore
 - Unidad de medida: L o m³
- CALIBRACION PH: 2 puntos, 1 punto, Referencia, Desactivado
- CALIBRACION ORP: 1 punto, Referencia, Desactivado

1. CALIBRACIÓN CL: 2 puntos, Desactivar,
 2. TEMPERATURA DE CALIBRACIÓN: Referencia, Desactivar,
 3. TIPO DE DOSIFICACIÓN PH: Proporcional, OFF, **CYCLE**, Timed, On/OFF
 1. **Nota:** Modo de dosificación de ciclo, está presente solo en la aplicación PoolDose SPA.
 4. TIPO DE DOSIFICACIÓN ORP: proporcional, OFF, **CYCLE**, Timed, On/OFF,
 1. **Nota:** La dosificación de ORP está desactivada si el **cloro de tipo de dosificación** es diferente de OFF
 2. **Nota:** Modo de dosificación de ciclo, está presente solo en la aplicación PoolDose SPA.
- TIPO DOSIFICACION CLORO: Proporcional, OFF, Temporizado, On/OFF
 - RELE AUX
 - RELE AUX1: pH, Desactivado
 - RELE AUX2: Cloro, ORP, Desactivado
 - **Nota:** Los relés Aux1 y Aux2 dosifican con el método ON/OFF
 - PASSWORD: 0000 (**Nota:** password disabitata, impostare un valore diverso da: 0000)
 - RESTABLECER CALIBRACION: (**Nota:** seleccionar la medida para restablecer: pH; Cloro; ORP)
 - RESTABLECER TODOS LOS PARAMETROS: RESTABLECER LOS PARAMETROS PREDETERMINADOS
 - CONTROL PANEL: muestra las señales eléctricas
 - CONFIGURACION WIFI
 - Nombre de la red WiFi
 - Contraseña de WiFi
 - Dirección IP de la red WiFi.
- Nota:** este menú está disponible solo para productos WiFi, no está presente en la aplicación PoolDose SPA.
- REED (error de visualización, cuando está rojo): NO/NC
 - POWER ON DELAY: (Retardo de encendido) Desactiva las bombas de dosificación durante el tiempo establecido (OFF...1:90 minutos)
 - FLOWDELAY: (Retardo de flujo) Desactiva las bombas de dosificación durante el tiempo establecido (OFF...1:60 minutos)

Nota: Tiempo de espera para el menú de configuración - después de 120 segundos sin acción, el controlador se escapa sin guardar los parámetros.

Ejemplo de pantalla

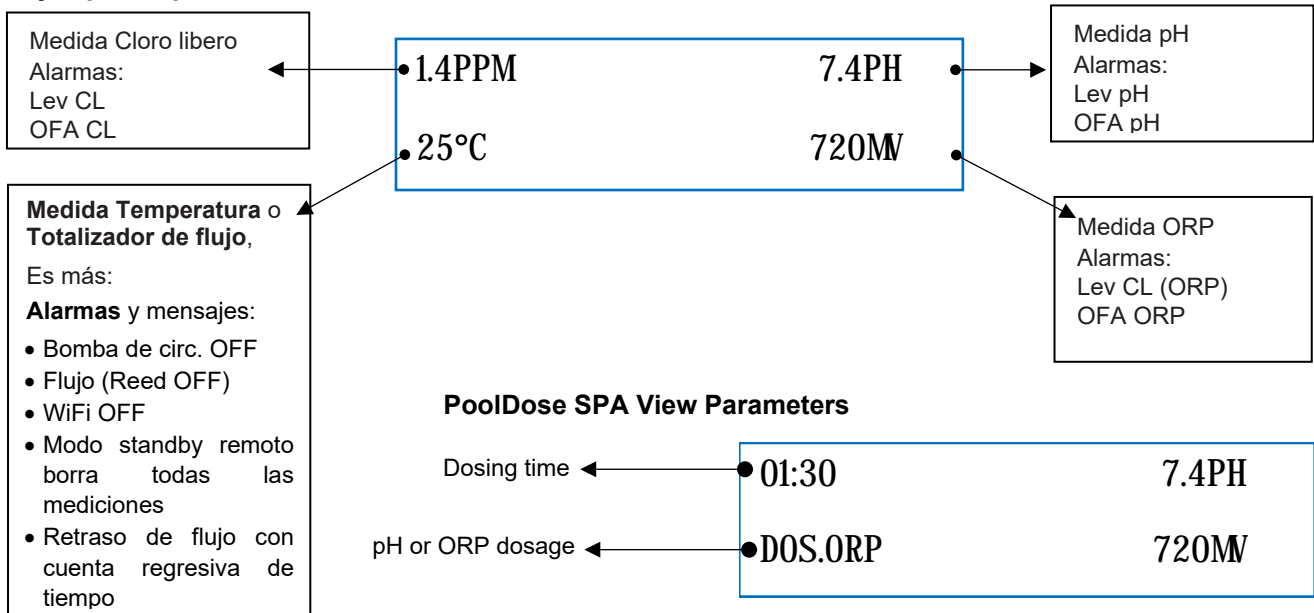



PoolDose | pH · ORP · Cloro

Menú de calibración:

Presione  (3 segundos) para calibrar la sonda de pH, Cloro, Temperatura, ORP

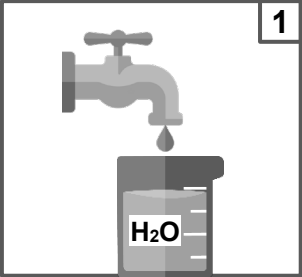
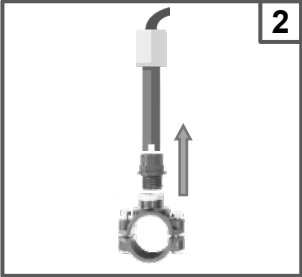
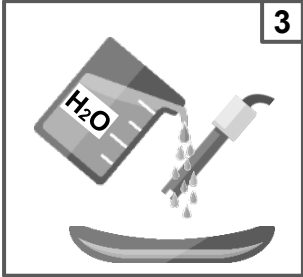
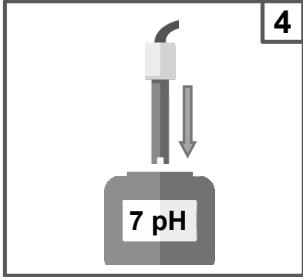
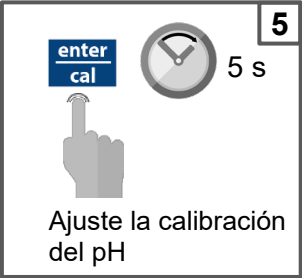
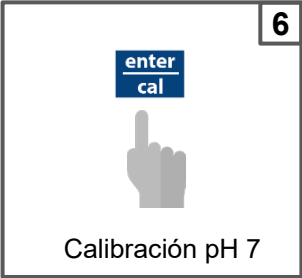
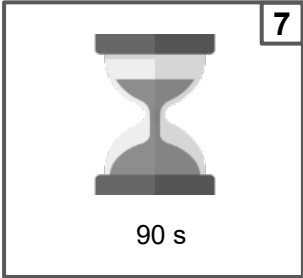
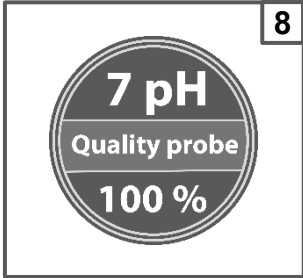
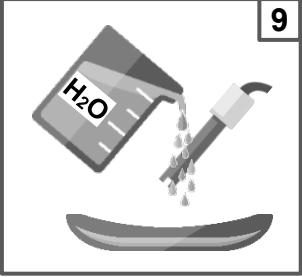
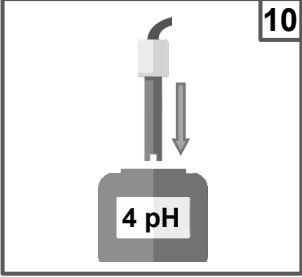
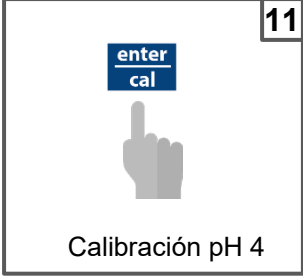
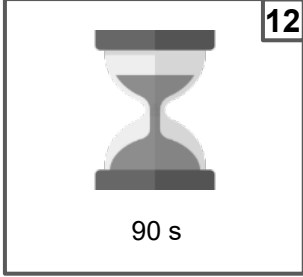
7. CALIBRACIÓN DEL pH

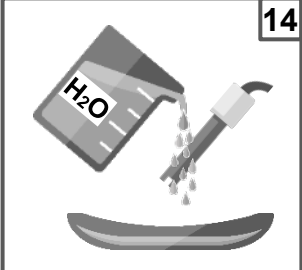
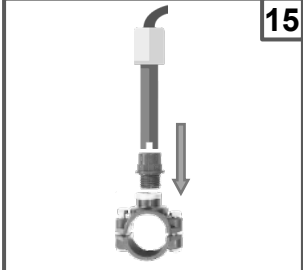
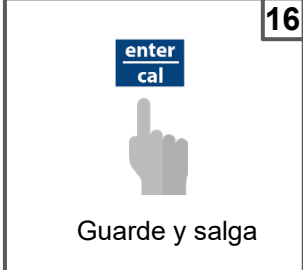
			
 <p>Ajuste la calibración del pH</p>	 <p>Calibración pH 7</p>	 <p>90 s</p>	
		 <p>Calibración pH 4</p>	 <p>90 s</p>
			 <p>Guarde y salga</p>

Nota: Si ha seleccionado la función “1 punto cal.”, la calibración se hará solamente en 1 punto usando la solución tampón de pH 7.

Calibración de referencia

CAL Referencia
7.2 pH

La unidad parpadeará un valor de pH

Establecer el valor medido con el instrumento

Ex. 7.4 pH

CAL Referencia
7.4 pH



8. CALIBRACIÓN REDOX

Calibración de referencia

CAL Referencia
720 mV

La unidad parpadeará un valor de redox

Establecer el valor medido con el instrumento

Ex. 750 mV

CAL Referencia
750 mV

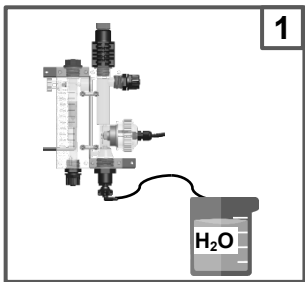
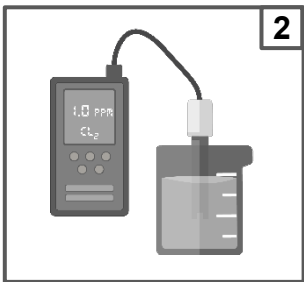
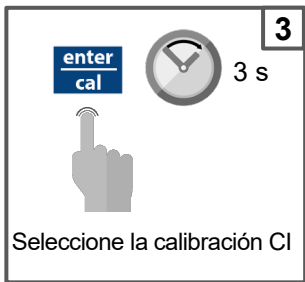
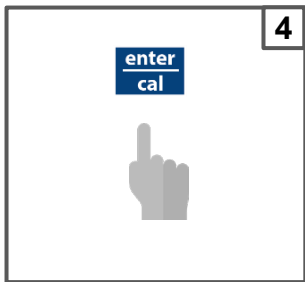
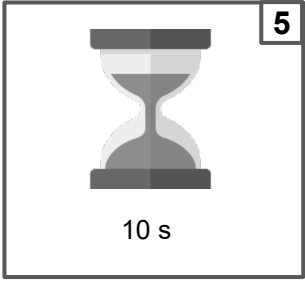
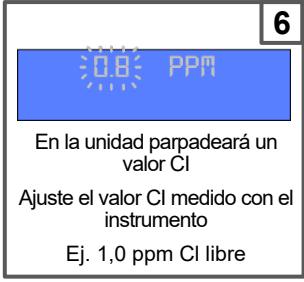
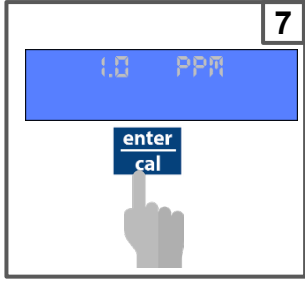
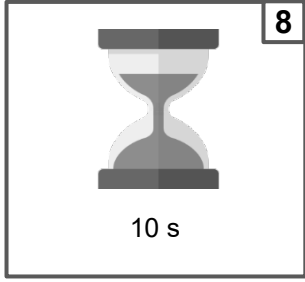
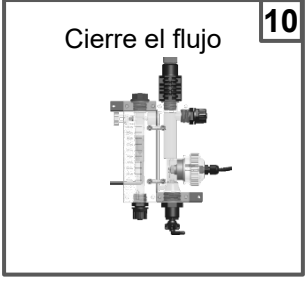
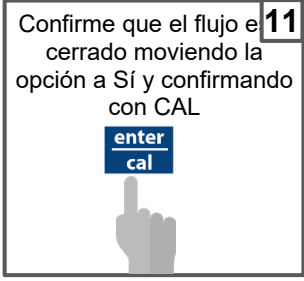
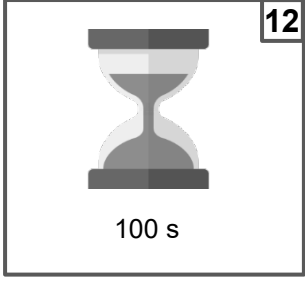
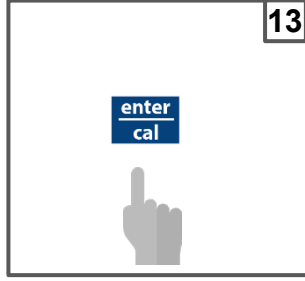
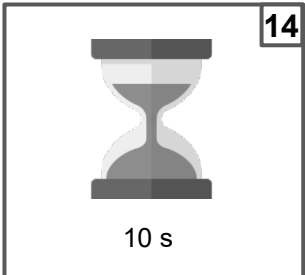
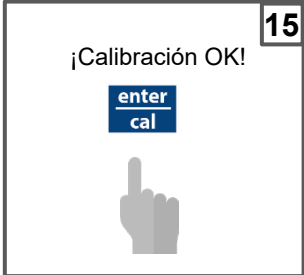

enter cal

9. CALIBRACIÓN DEL CLORO

 <p>1</p>	 <p>2</p>	 <p>3</p> <p>3 s</p> <p>Seleccione la calibración Cl</p>	 <p>4</p>
 <p>5</p> <p>10 s</p>	 <p>6</p> <p>En la unidad parpadeará un valor Cl</p> <p>Ajuste el valor Cl medido con el instrumento</p> <p>Ej. 1,0 ppm Cl libre</p>	 <p>7</p>	 <p>8</p> <p>10 s</p>
 <p>10</p> <p>Cierre el flujo</p>	 <p>11</p> <p>Confirme que el flujo es cerrado moviendo la opción a Sí y confirmando con CAL</p>	 <p>12</p> <p>100 s</p>	 <p>13</p>
 <p>14</p> <p>10 s</p>	 <p>15</p> <p>¡Calibración OK!</p>		

* Presione ESC para salir del menú de calibración.

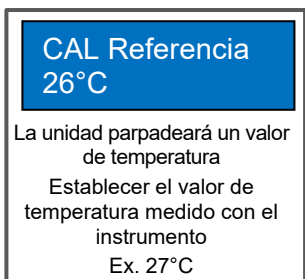
10. CALIBRACION DE LA TEMPERATURA

 <p>CAL Referencia 26°C</p> <p>La unidad parpadeará un valor de temperatura</p> <p>Establecer el valor de temperatura medido con el instrumento</p> <p>Ex. 27°C</p>	 <p>CAL Referencia 27°C</p> <p>enter cal</p>
--	---

PoolDose | pH · ORP · Cloro

Menú de configuración

Pulsar **set** (3 segundos) para ajustar el valor del Setpoint y pulsar **set** para confirmar.



Menú de calibración

Pulsar **enter cal** (3 segundos) para calibrar la sonda de pH, Cloro, Temperatura, ORP

Modo StandBy

Pulsar **▼ ▲** (5 segundos) el sistema entra en modo StandBy; todas las funciones están desactivadas.

Reset Temporizador OFA

Presione **menu esc** (3 segundos) para restablecer la alarma OFA o presione **▲ ▼** (5 segundos) para restablecer la alarma OFA.

Cebado de las bombas

Solo con la bomba en "modo stand-by" pulsar **▲** para restablecer el totalizador de flujo, pulsar **▼** para hacer funcionar la bomba de pH, pulsar **menu esc** para hacer funcionar la bomba de ORP/Cloro, pulsar **enter cal** para hacer funcionar el Relé Aux1, pulsar **set** para hacer funcionar el Relé Aux2.

Dosificación PoolDose SPA

La regulación de pH y cloro en el sistema PoolDose Spa se gestiona manteniendo la regulación del pH antes de la dosificación de cloro para obtener una mejor regulación. Esta función solo está disponible en los productos PoolDose SPA.

Para restaurar los parámetros por defecto, siga los siguientes pasos:

- Apague la unidad PoolDose
- Mantenga **▲** y **▼** pulsados y encienda la unidad
- La unidad mostrará **INIT.DEFAULT**
- Seleccione la unidad a resetear - módulo WiFi o sistema de dosificación
- Pulse **▲** o **▼** para seleccionar **SI** o **NO**
- Seleccione **SI** y presione **enter cal** para restablecer los parámetros por defecto.

Parámetros por defecto:

- Idioma = **EN**
- Valor del Setpoint = **7,2 pH; 700 mV; 1,2 ppm**
- Modo de dosificación = **Acido (pH); Bajo (Redox); Bajo (Cl)**
- Tiempo OFA = **OFF**
- Calibración = **Full**
- Entrada de flujo = **OFF (bomba de recirculación)**
- Método de dosificación = **PROP; ON/OFF Relé Aux1 y Aux2**
- IN Freq. = **OFF**
- Reed = **NC (normalmente cerrado)**
- P.ON (retardo a la activación) = **OFF**
- Retardo de flujo = **OFF**

11. MÉTODO DE DOSIFICACIÓN

Punto de ajuste = 7,2 pH

Modo de dosificación = Acido

Banda proporcional = 1,0 pH (* valor no modificable)

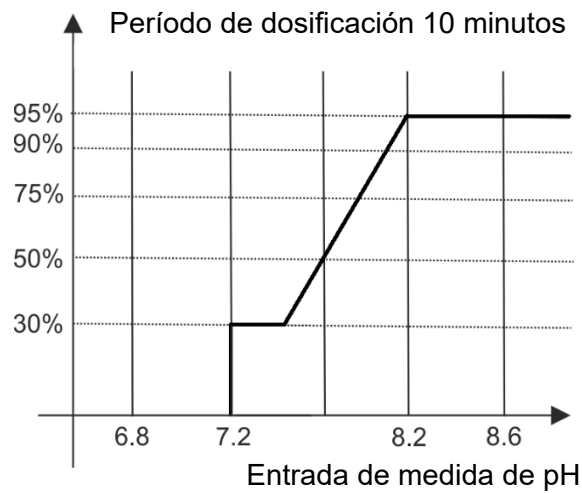

Punto de ajuste = 700 mV

Modo de dosificación = Bajo

Banda proporcional = 250mV (* valor no modificable)

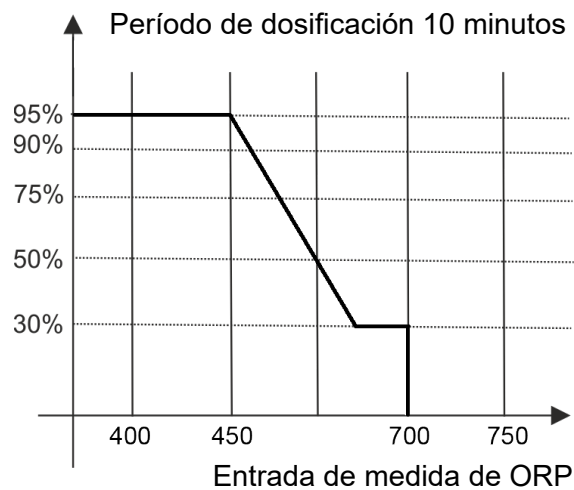

Punto de ajuste = 1,2ppm Cloro libre

Modo de dosificación = Bajo

Banda proporcional = 0,8ppm (* valor no modificable)

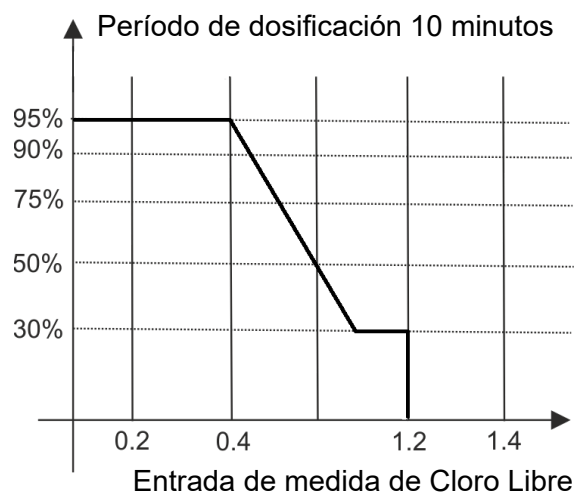

12. MÉTODO DE DOSIFICACIÓN CICLO

El método de dosificación del ciclo solo está disponible en el modelo PoolDose SPA

Los ciclos deben ser los siguientes:

- 20 minutos de espera

- 4 min de ciclo de dosificación en proporción para la dosificación del pH (si el pH no requiere dosificación, el

- sistema puede administrar la dosis de Rx si es necesario) (prioridad al pH)

- 20 minutos de espera

- 4 min de ciclo de dosificación en proporción para la dosificación del pH (si el pH no requiere dosificación, el

- sistema puede administrar la dosis de Rx si es necesario) (prioridad al pH)

Exct.

Proporcionalmente significa:

El plazo es de 60 segundos:

Como la lectura está al 90 % del punto de consigna, el tiempo de ejecución es de 14 segundos

Como la lectura está al 75 % del punto de consigna, el tiempo de ejecución es de 20 segundos

Como la lectura está al 50 % del punto de consigna, el tiempo de ejecución es de 30 segundos

Como la lectura está al 25 % del punto de consigna, el tiempo de ejecución es de 40 segundos

Alarma para el punto de ajuste pH/Redox

Cuando se establece la banda de alarma, se crea una ventana de trabajo. Si los límites permitidos se superan, el relé de alarma se cierra y permanece cerrado hasta que la medición se reinicia o se pulsa **enter/cal** para desactivar la alarma.

Cuando el tiempo OFA (Over Feed Alarm, o alarma de suministro excesivo) se establece, el tiempo de dosificación de punto de ajuste pH/Redox a tiempo se controla mediante dos alarmas:

- La primera alarma al 70 % del tiempo programado se ve en la pantalla, y el relé de alarma se cierra.
- La segunda alarma al 100 % del tiempo programado se ve en la pantalla, el relé de alarma se cierre y la bomba pH/Redox se bloquea.

Presione **menu/esc** (3 segundos) para restablecer la alarma OFA o presione **▲ ▼** (5 segundos) para restablecer la alarma OFA.

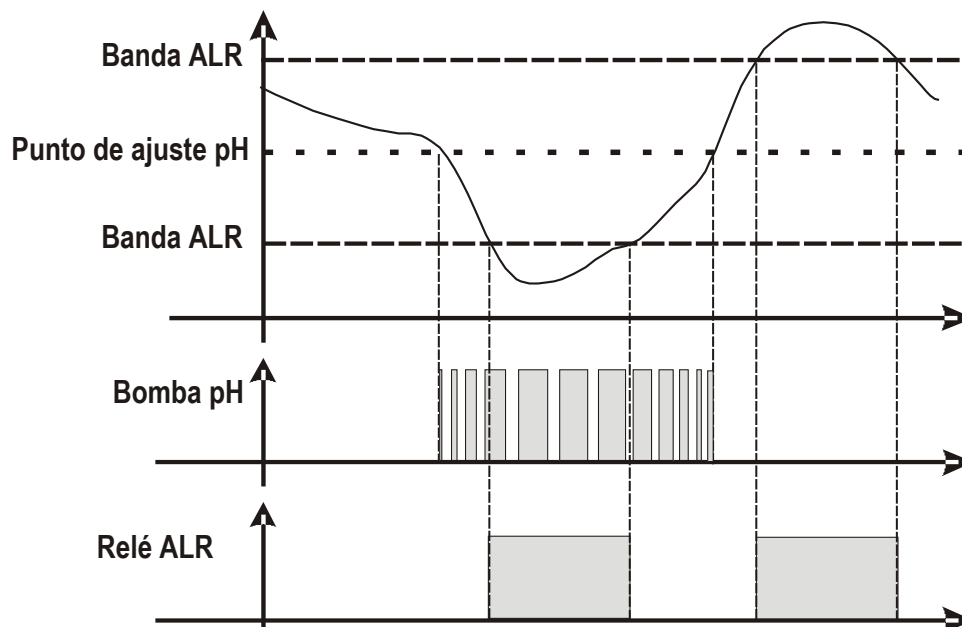

(*1 Intervalos de medidas alarmas – valores fijos)

n	Item	Limites
1	Medida Temp. min	+ 10°C
2	Medida Temp. Max	+ 38°C
3	Medida pH min	6 pH
4	Medida pH Max	8 pH
5	Medida ORP min	+ 600 mV
6	Medida ORP Max	+ 800 mV
7	Medida CL min	0,50 ppm
8	Medida CL Max	2 ppm

13. WEB SERVER INTERNO

Descargar la aplicación **SekoLink**

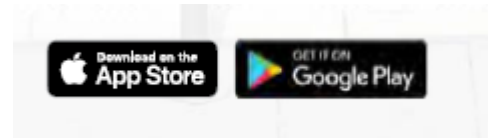

Registre su cuenta

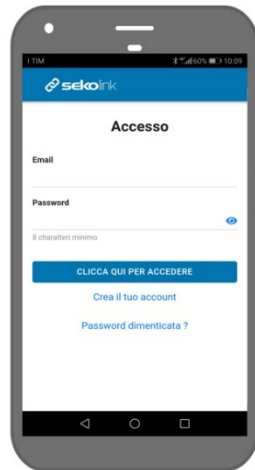

Con el QrCode, acceder en las páginas web internas
Establecer:

User name= ADMIN
Password= 0000



Configurar su conexión Wi-Fi LAN Nombre y Contraseña y confirmar



Complete el registro del su dispositivo

PoolDose | pH · ORP · Cloro

Gracias a su registro, es posible utilizar **sekolink** y **sekoweb** de forma gratuita.



sekolink

Gracias a **sekolink** es posible gestionar su piscina:

- Seguimiento con gestión limitada
- Aplicación para smartphone compatible con iPhone o Android
- Para usuarios finales













sekoweb

Utilice la dirección de **sekoweb** www.sekoweb.com o la aplicación para gestionar sus piscinas con un portal web profesional:

- Seguimiento con gestión completa
- Portal de Internet accesible mediante inicio de sesión en línea o escaneando el código QR de un producto
- Para instaladores, técnicos e ingenieros de piscinas y spa



14. ALARMAS

Alarma	Pantalla	Acciones para realizar
Nivel *solo medidas activas	LEV BAJO	- Pulse  para abrir el relé de alarma. - Restablezca el tanque de producto.
Medida fuera de rango	ALARMBAND	- Sustituya o compruebe la sonda de medición. - Pulse  para abrir el relé de alarma. - Restablezca la medida.
Primera alarma OFA (tiempo >70 %)	OFA_1	- Presione  durante 3 segundos para reiniciar o presione   durante 5 segundos para reiniciar
Segunda alarma OFA (tiempo 100 %)	OFA_2	- Presione  durante 3 segundos para reiniciar o presione   durante 5 segundos para reiniciar
Caudal	FLUJO	- Restablezca el caudal.
Función de calibración	ERROR CALIBRACION	- Restaure la sonda o la solución tampón y repita el procedimiento de calibración.
Error del sistema	ERROR PARAMETROS	- Pulse  para restablecer el parámetro por defecto. - Unidad rota.
Alarma de medida (*1)	MEDIDA ALTA MEDIDA BAJA	- Ajustar la concentración del producto químico
El menú WiFi no está presente en el menú avanzado, pero la tarjeta WiFi está presente	EL MENU WIFI NO ESTA PRESENTE	- Apagar la unidad, mantener presionada  y encender.
Medida de error	MEDIDA INCORRECTA	- Por favor, restablezca el parámetro de calibración , en Advanced Menu haga clic para <u>Restablecer elemento CAL.</u>

(*1 Intervalos de medidas alarmas)

n	Item	Limites
1	Medida Temp. min	+ 10°C
2	Medida Temp. Max	+ 38°C
3	Medida pH min	6 pH
4	Medida pH Max	8 pH
5	Medida ORP min	+ 600 mV
6	Medida ORP Max	+ 800 mV
7	Medida CL min	0,50 ppm
8	Medida CL Max	2 ppm

15. MANEJO

Sustitución de la manguera:

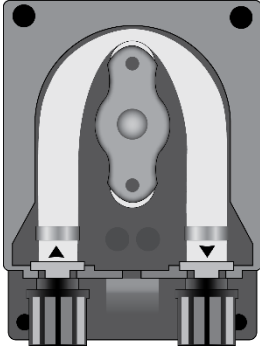

Abra la tapa de la bomba y suelte la manguera tirando del conector izquierdo hacia arriba.

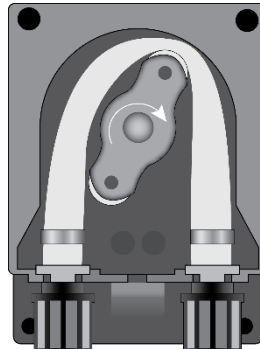

Coloque el carrete a las 7h05, girándolo en la dirección de la flecha circular.

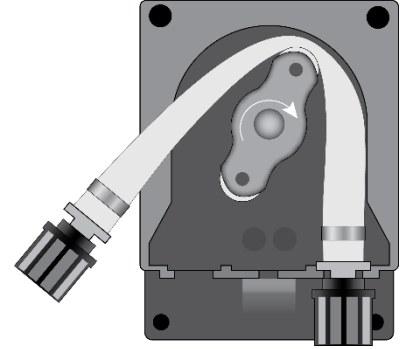

Suelte por completo el conector izquierdo, manteniéndolo tenso hacia el exterior, y gire el carrete en la dirección de la flecha circular para que la manguera quede suelta hasta el conector derecho.

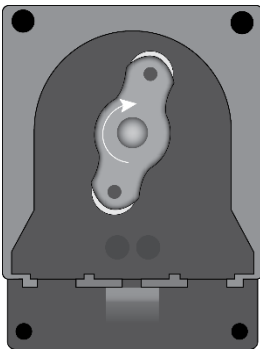

Coloque el carrete a las 7h05 girándolo en la dirección de la flecha circular.

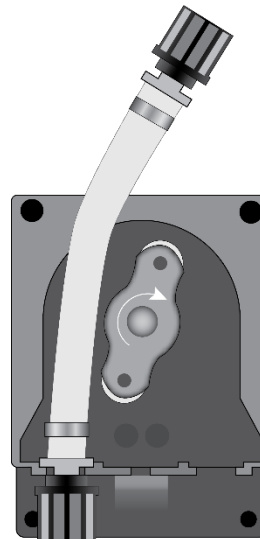

Introduzca el conector izquierdo en el compartimento correspondiente y pase la manguera por debajo de la guía del carrete. Gire el carrete en la dirección de la flecha circular, acompañando al mismo tiempo la manguera dentro del cabezal de la bomba hasta alcanzar el conector derecho.

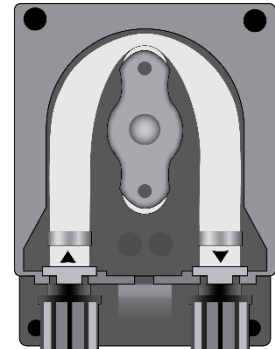

Cierre la tapa de la bomba y presione la superficie para que quede correctamente encajada en su sitio.

* Procedimiento de sustitución de tubo válido para 2 y 3 rodillos.

16. ALMACENAMIENTO DE LA BOMBA TRAS SU USO

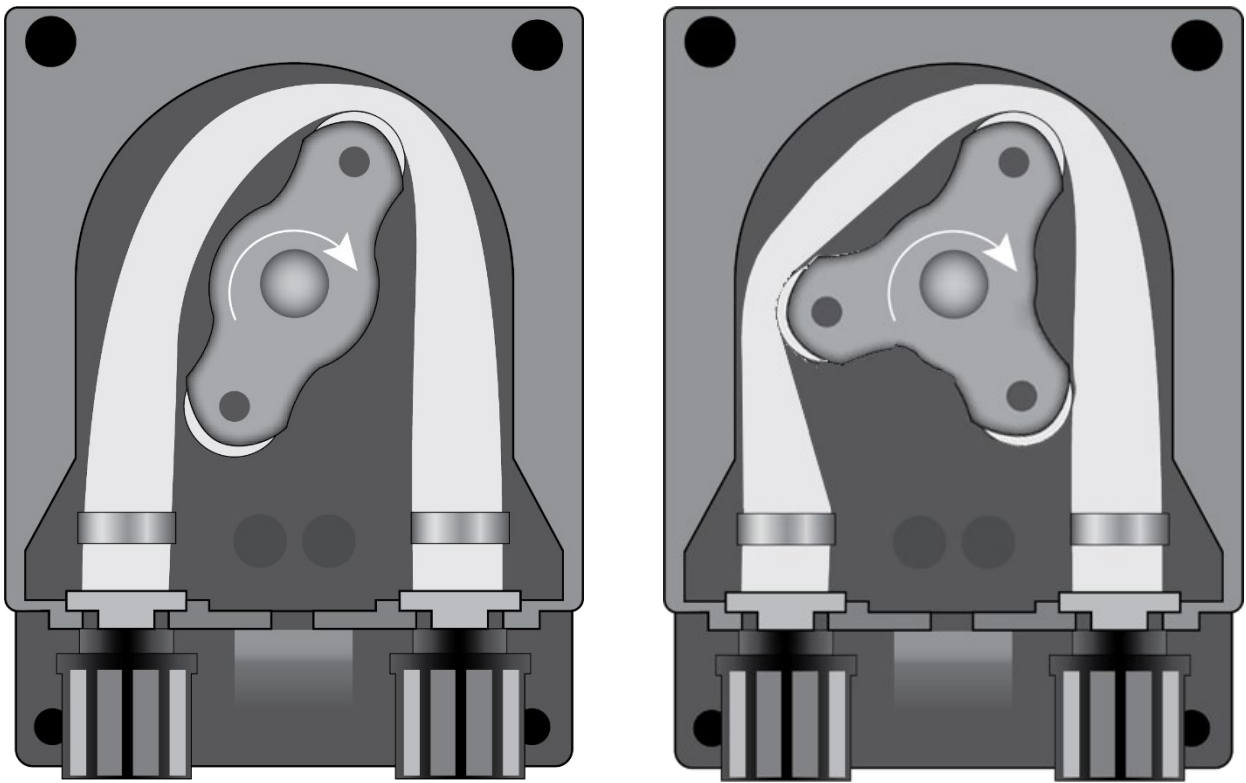

Cuando el dispositivo de regulación tenga que almacenarse, debe bombearse agua limpia a través de la manguera para enjuagarlo.

A continuación, coloque el carrete a las 7h05 girándolo en la dirección indicada por la flecha circular.

Estas dos medidas facilitarán la posterior reactivación de la unidad.

PoolDose | pH · ORP · Cloro

Conexiones eléctricas:

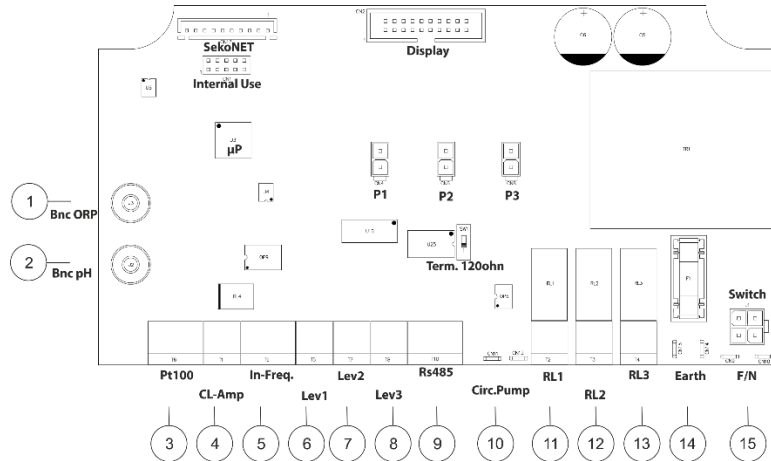

Etiqueta de conexiones:

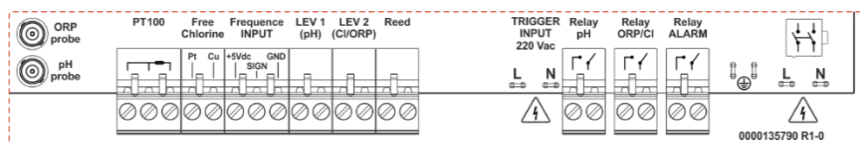

Abrazadera	Descripción	PoolDose pH · ORP	
1	Entrada de sonda	ORP	Sonda ORP
2	Entrada de sonda	pH	Sonda pH
3	Entrada de sonda	TEMP (PT100) A= Sensor de temp. con dos cables B= Sensor de temp. con tres cables	
4	Entrada de sonda Cloro libre	Entrada de sonda Cloro libre: Pt: Sensor de platino Cu: Sensor de cobre	
5	Entrada de señal de frecuencia	Caudal (Entrada frecuencia) A= Mecánico Reed B= Padwheel con sensor Hall	
6	Nivel (tanque de producto)	Sonda de nivel pH	Sonda de nivel tanque de producto
7	Nivel (tanque de producto)	Sonda de nivel Cloro (ORP)	Sonda de nivel tanque de producto
8	Nivel (tanque de producto)	Caudal (Sensor REED)	Sensor de flujo
9	Porto Serial	No presente	No presente
10	Entrada de disparo	Bomba de recirculación (Entrada 220Vac)	Fili Fase/Neutro
11	Salida de relé	RL1 AUX1 pH	Contacto seco
12	Salida de relé	RL2 AUX2 OPR/Cloro	Contacto seco
13	Salida de relé	RL3 Alarma	Contacto seco
14	Conector de tierra	Tierra	---
15	Fuente de alimentación	220-240 Vac 50-60 Hz (F/N)	---



ATTENTION !

Avant de procéder à TOUTE intervention à l'intérieur du panneau de commande de l'appareil PoolDose, assurez-vous de le débrancher de l'alimentation électrique.

Le non-respect des instructions contenues dans ce manuel peut entraîner des blessures aux personnes et/ou endommager l'appareil et le système.

1. CONTENU DE L'EMBALLAGE

A : Tuyau d'aspiration PVC transparent 4x6 (4 m)	B : Tuyau d'alimentation en polyéthylène (5 m)	C : Valve à lèvres FPM (GAZ 3/8")	D : Porte-sonde PSS3 (GAZ 1/2")	E : Sellette de raccordement (φ=50mm)	F : Réducteur pour soupape d'injection (1/2" M vers 3/8" F)
G : Filtre au pied (Rehausse PP)	H : Kit support de montage (φ=vis de 6 mm)	L : Capteur de température	M : sonde pH	N : Sonde redox	O : Porte-sondes + sonde chlore
P : Filtre secondaire (5") + Porte-sonde PSS3 (GAZ 1/2")	Q : Brosse de nettoyage de la sonde de chlore	R : Billes pour la sonde de chlore	S : Solution tampon pH 4	T : Solution tampon pH 7	U : Solution d'étalonnage 465 mv
V : Eau					

Article *	Système	Système de pompe double	
		PoolDose pH / ORP	PoolDose pH / ORP / CL
A		2	2
B		2	2
C		2	2
D		2	-
E		4(*1)	4(*1)
F		2	2
G		2	2
H		1	1
L		1 (*2)	1 (*2)
M		1	1
N		1	1
O		-	1
P		-	1
Q		-	1
R		-	1
S		1	1
T		1	1
U		1	1
V		1	1

* Les valeurs du tableau représentent le nombre d'éléments contenus à l'intérieur du paquet.

(*1 Cinq pièces pour le modèle WiFi uniquement)

(*2 Une seule pièce pour le modèle WiFi uniquement)

AVERTISSEMENT !

Ces produits sont **DANGEREUX (I✳A)** et requièrent des précautions particulières lors de leur utilisation, leur manipulation et leur stockage.

- **NE JAMAIS mélanger les produits chimiques.**
- **NE JAMAIS** laisser des enfants ou des personnes qui n'ont pas lu ce manuel, utiliser ou manipuler PoolDose ou l'un de ses composants périphériques (y compris les produits chimiques).

Produits chimiques concernant le pH :

- **ABSOLUMENT** non recommandé => acide sulfurique pur
- Recommandé pour abaisser le pH => pH négatif (avec une base d'acide sulfurique)
- Recommandé pour élever le pH => pH positif (carbonate ou bicarbonate de sodium)

Produits chimiques concernant l'oxydoréduction :

- **ABSOLUMENT** non recommandé => tous les types de chlore organique
- Du chlore liquide ou de l'eau de Javel à 12% peuvent être utilisés à l'état pur. Si le produit a une concentration de 48%, il est nécessaire de le diluer dans l'eau dans un rapport 1:3.

Les sondes pH/Redox sont sujettes à l'usure et ne sont donc pas couvertes par la garantie.

2. INSTRUCTIONS D'INSTALLATION

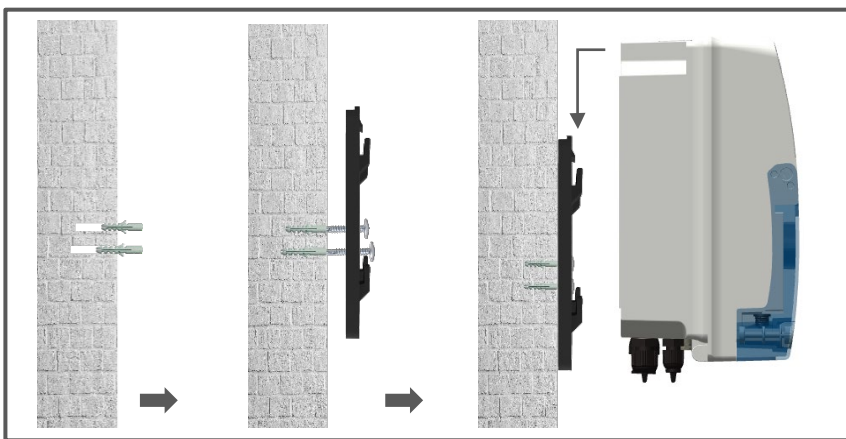

Assurez-vous que la pression d'injection est inférieure à 1,5 bar

Positionnement de la sonde

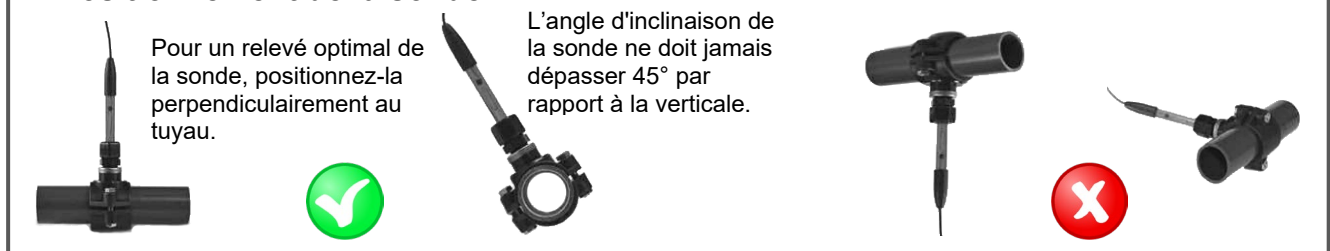

Unité d'installation

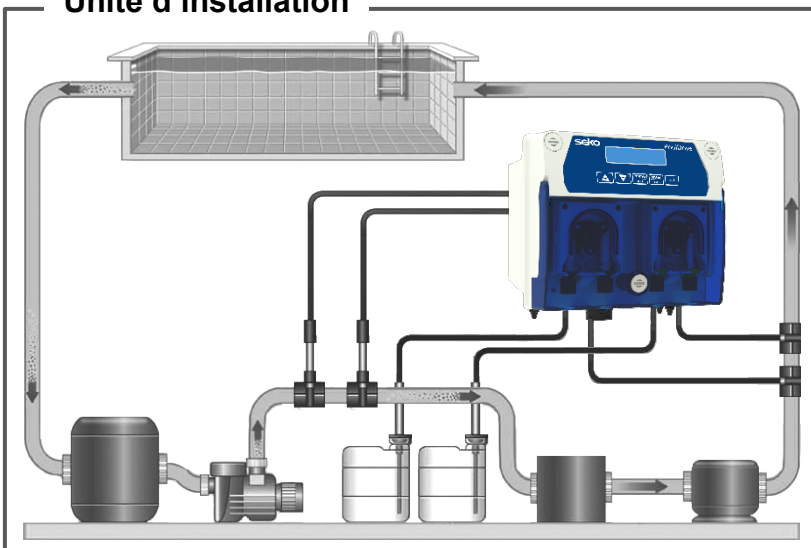

Avertissement !

Utilisation avec l'électrolyseur au sel :

Pour les systèmes de pH, pour éviter le risque de dysfonctionnement ou d'endommagement, respectez les instructions suivantes :

1. Placez la sonde de mesure du pH en amont de la cellule de l'électrolyseur.
2. Pour éliminer les courants de Foucault, branchez l'eau de la piscine sur un point de masse électrique
3. Placez le point d'injection du produit en aval de la cellule de l'électrolyseur.

3. RACCORDEMENTS ELECTRIQUES

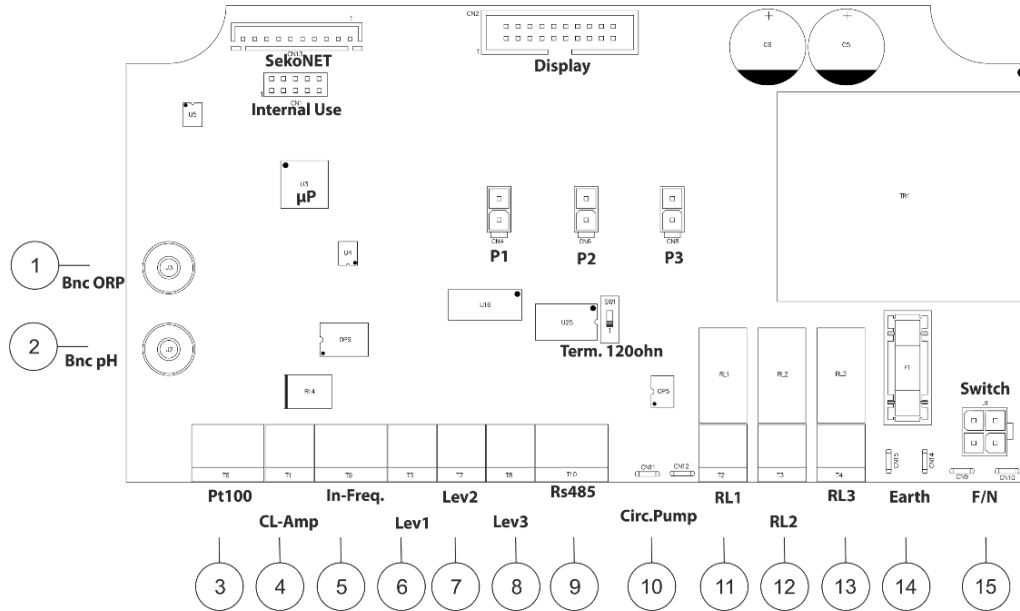

Serrage	Description	Système de pompe double	
		PoolDose pH · ORP	PoolDose pH · ORP · CL
1	Sonde d'entrée	ORP	ORP
2	Sonde d'entrée	pH	pH
3	Sonde d'entrée	TEMP (PT100)	TEMP (PT100)
4	Sonde d'entrée	Non utilisé	Chlore Libre
5	Entrée signal fréq.	Débit (entrée fréq.)	Débit (entrée fréq.)
6	Niveau (réservoir de produit)	Sonde de niveau pH	Sonde de niveau pH
7	Niveau (réservoir de produit)	Sonde de niveau Chlore (ORP)	Sonde de niveau Chlore
8	Niveau (Capteur de débit Reed externe)	Débit (capteur REED)	Débit (capteur REED)
9	Port série	Pas présent	Pas présent
10	Entrée de déclenchement 220Vac (haute tension)	Pompe de circulation (entrée 220Vac)	Pompe de circulation (entrée 220Vac)
11	Relais de sortie R1	RL1 AUX1 pH	RL1 AUX1 pH
12	Relais de sortie R2	RL2 AUX2 OPR/Chlore	RL2 AUX2 OPR/Chlore
13	Relais de sortie R3	Alarme RL3	Alarme RL3
14	Connecteur de terre	Terre	Terre
15	Alimentation électrique	220-240 Vac 50-60 Hz (F/N)	220-240 Vac 50-60 Hz (F/N)
P1	Raccordement de la pompe péristaltique	pH	pH
P2	Raccordement de la pompe péristaltique	Chlore (ORP)	Chlore
P3	Raccordement de la pompe péristaltique	Non utilisé	Non utilisé
SekoNet	Module WiFi	Carte WiFi (code produit dédié)	Carte WiFi (code produit dédié)

Étiquette de connexions

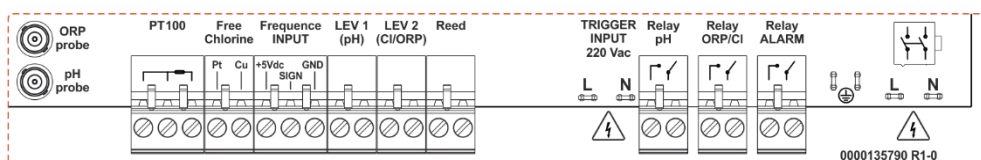

4. SPECIFICATIONS TECHNIQUES

Spécifications	PoolDose Double pH/ORP	PoolDose Double pH/ORP/Chlore
Dimensions (H-L-P)	H:194,5 x L:205,1 x P:132,8 mm	H:194,5 x L:205,1 x P:132,8 mm
Poids	3,5 Kg	3,5 Kg
État de la pompe	Pause - Alimentation	Pause - Alimentation
Étalonnage de sonde	Automatique	Automatique
Alimentation électrique	220-240 VAC 50-60 Hz	220-240 VAC 50-60 Hz
Consommation	28 Watt	28 Watt
Précision de l'appareil	± 0,1 pH; ±10mV; ±1°C	± 0,1 pH; ±10mV; 0,1 ppm; ±1°C
Précision	±0,02pH, ±3mV;±0,5°C	±0,02pH, ±3mV; 0,05 ppm;±0,5°C
Plage	0-14 pH; -99 -1000mV; 0...+55°C	0-14 pH; -99 -1000mV; 0-5 ppm; 0...+55°C
Débit de la pompe	1,5 l/h	1,5 l/h
Débit de la pompe (modèle SPA uniquement)	0,4 l/h	Indisponible
Contre-pression maxi	1,5bar	1,5bar
Contact relais (numéro 3)	250 Vac 10A (charge résistive)	250 Vac 10A (charge résistive)
Fusible	500 mA (vite)	500 mA (vite)

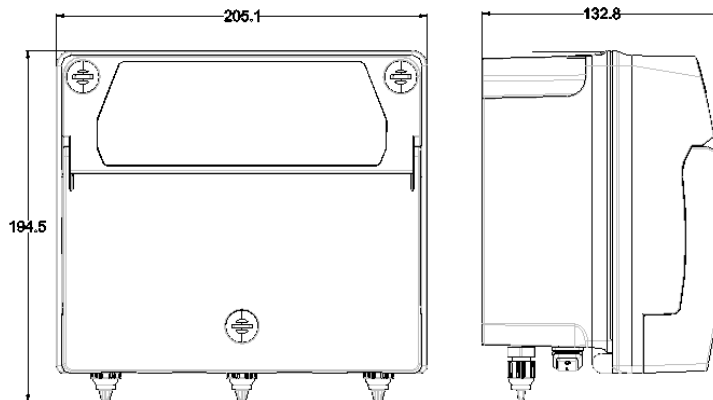

5. DISPOSITIF SUPPRESSEUR ÉLECTRIQUE

It is mandatory to install the coil suppressor please below the instruction procedure:

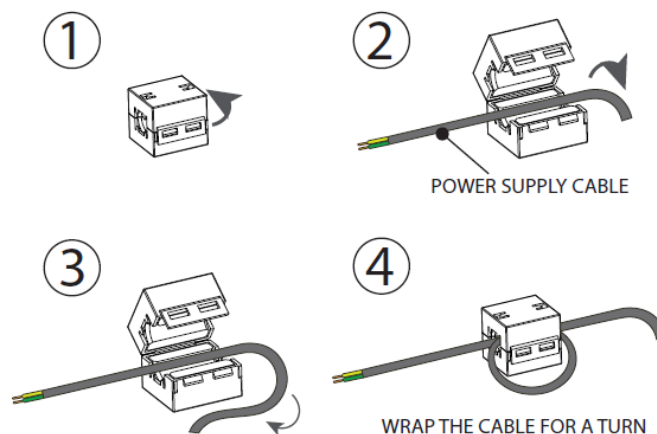

6. INSTRUCTIONS DE CONFIGURATION SYSTEME POOLDOSE

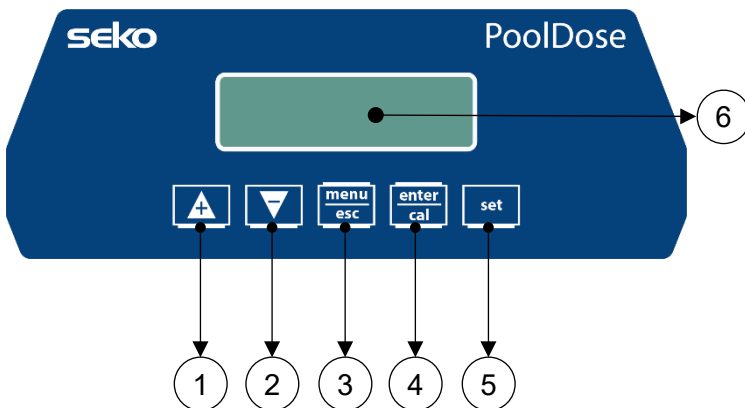

- 1) Bouton pour augmenter la valeur
- 2) Bouton pour diminuer la valeur
- 3) Bouton Menu/Échapp
- 4) Bouton Étal/OK
- 5) Bouton pour configurer le point de consigne
- 6) Écran numérique

Configuration du programme – Appuyer sur **menu/esc** pendant 5 secondes

À l'entrée de chaque élément de menu, le paramètre peut être modifié directement à l'aide des touches fléchées (**▲** et **▼**).

Appuyer sur le bouton **enter/cal** pour confirmer le réglage actuel et passer au prochain élément.

Le menu a une structure circulaire : une fois arrivé au dernier élément, la confirmation du jeu de paramètres, en appuyant sur **enter/cal**, détermine le retour au premier élément de menu.

1 LANGUE – Il est possible de choisir parmi 5 langues disponibles : **EN**, **FR**, **IT**, **DE**, **ES**

2 PH

- POINT DE CONSIGNE – **7,2 pH** (6-8 pH)
- TYPE_DOSAGE – **Acide** (Acid/Alka)
- TIME_ON = 30 secondes (plage de 1 à 360 secondes)
- TIME_OFF = 60 secondes (plage de 1 à 360 secondes)
- TEMPERATURE : 25°C; régler °C / °F et la valeur manuelle
- ALARME OFA : Désactivé, 1-60' (minutes)

* Dosage temporisé uniquement

3 ORP

- POINT DE CONSIGNE – **700 mV** (400-850 mV)
- TYPE_DOSAGE – **Bas** (Bas/Haut)
- TIME_ON = 30 secondes (plage de 1 à 360 secondes)
- TIME_OFF = 60 secondes (plage de 1 à 360 secondes)
- ALARME OFA : Désactivé, 1-60' (minutes)
- **Remarque:** Le dosage ORP, en présence de chlore, n'a aucun effet sur la pompe doseuse, mais peut gérer le relais Aux2 avec activation ON / OFF par rapport au point de consigne.

* Dosage temporisé uniquement

4 CHLORE

- POINT DE CONSIGNE – **1,2 ppm** (0,3-3,0 ppm)
- TYPE DOSAGE – **Bas** (Bas/Haut)
- TIME ON = 30 secondes (plage de 1 à 360 secondes)
- TIME OFF = 60 secondes (plage de 1 à 360 secondes)
- ALARME OFA : Désactivé, 1-60' (minutes)

* Dosage temporisé uniquement

5 MENU AVANCE

- POMPE DE RECIRCULATION – (Activée/Désactivée)
- D'ENTREE DEBIT
 - OFF/ON
 - Impulsion/litre: 1 ou litre/impulsion: 1 - Valeur de consigne
 - Mesure unité L ou m³
- ETALONNAGE PH: 2 points, 1 point, Référence, Désactiver
- ETALONNAGE ORP: 1 point, Référence, Désactiver

- **ÉTALONNAGE CL:** 2 points, Désactiver,
- **TEMPÉRATURE DE CALIBRACIàN:** Référence, Désactiver,
- **TYPE DE DOSAGE DE PH:** Proporcional, OFF, **CYCLE, Timed**, On/OFF
 - **Remarque:** Le mode de dosage du cycle est présent uniquement dans l'application PoolDose SPA.
- **TYPE DE DOSAGE ORP:** proporcional, OFF, **CYCLE**, Timed, On/OFF,
 - **Remarque :** Le dosage de l'ORP est désactivé si LE TYPE DE DOSAGE DE CHLORE est différent de OFF
 - **Remarque:** Le mode de dosage du cycle est présent uniquement dans l'application PoolDose SPA.
- **TYPE DOSAGE CHLORE:** Prop, Désactivé, Temporisé, On/OFF
- **AUX RELAY**
 - **RELAIS AUX1 :** pH, Désactivé
 - **RELAIS AUX2 :** Chlore, ORP, Désactivé
 - **Remarque:** Dosage des relais Aux1 et Aux2 avec méthode ON / OFF
- **PASSWORD:** 0000 (**Remarque:** mot de passe désactivé, définissez une valeur autre que: 0000)
- **REINITIALISER ETALONNAGE:** (**Remarque:** sélectionnez la mesure à réinitialiser: pH; Chlore; ORP)
- **REINITIALISER TOUS LES PARAMETRES:** REINITIALISER LES PARAMETRES PAR DEFAULT
- **PANNEAU DE COMMANDE:** affiche les signaux électriques
- **CONFIGURATION WIFI**
 - Nom du réseau WiFi
 - Mot de passe WiFi
 - Adresse IP du réseau WiFi.

Remarque : ce menu est disponible pour le produit WiFi uniquement, il n'est pas présent dans l'application PoolDose SPA.

- **REED** (erreur d'affichage, lorsqu'il est rouge): NO/NC
- **DELAI P ON:** Les pompes doseuses sont désactivées pendant la durée définie (OFF...1:90 minutes)
- **DELAI DEBIT:** Les pompes doseuses sont désactivées pendant la durée définie (OFF...1:60 minutes)

Remarque: Délai d'attente pour le menu de réglages - après 120 secondes sans action, le contrôleur s'échappe sans enregistrer les paramètres.

Exemple d'affichage

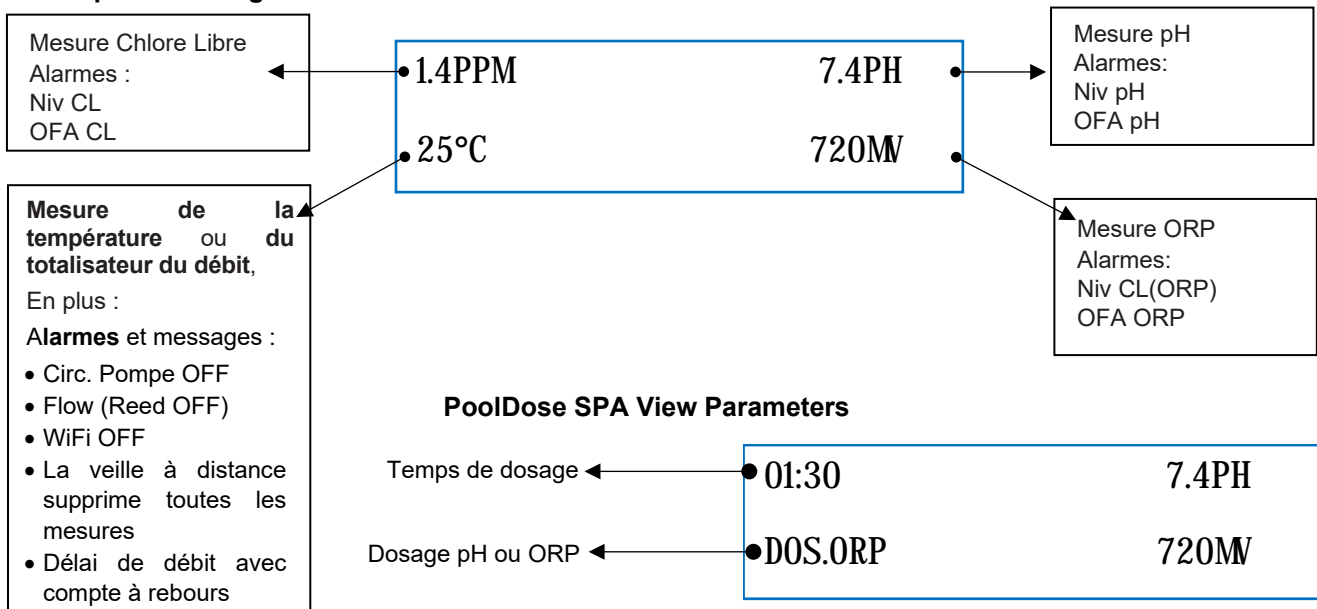



PoolDose | pH · ORP · Chlore

Menu d'étalonnage :

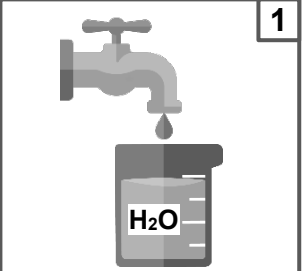
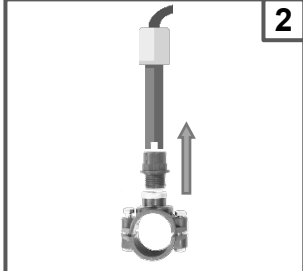
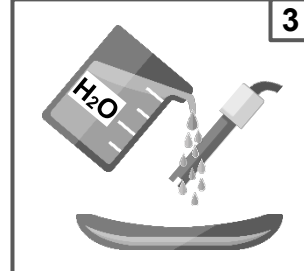
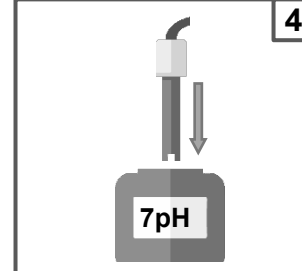
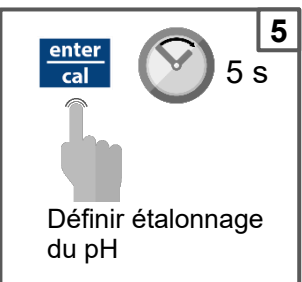
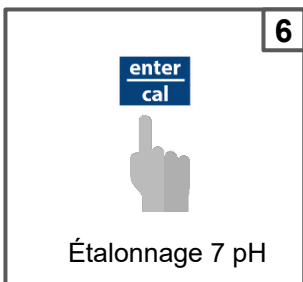
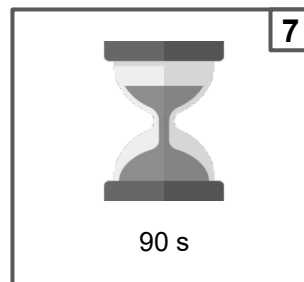
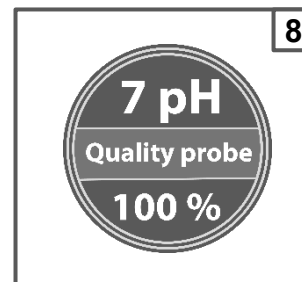
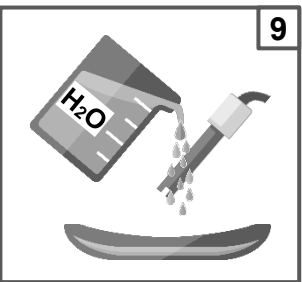
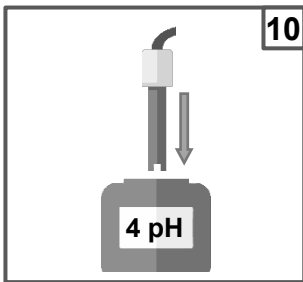
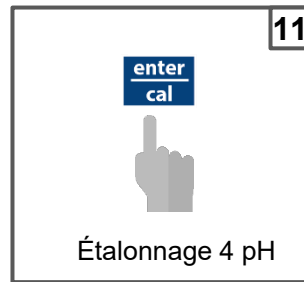
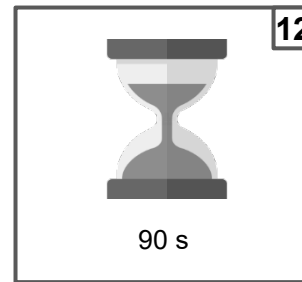
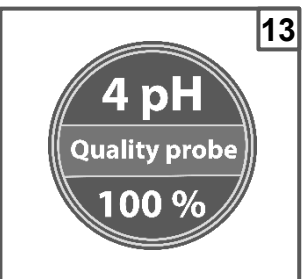
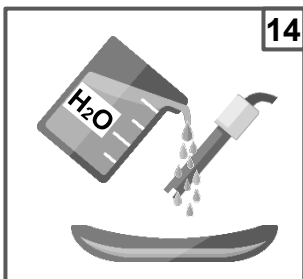
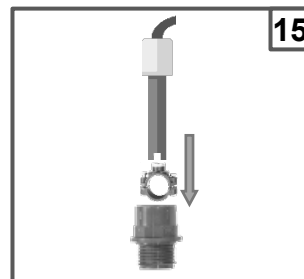

Appuyez sur  (3 secondes) et calibrer la sonde pH, Chlore, Température, ORP.

7. ÉTALONNAGE pH

 1	 2	 3	 4
 5 Définir étalonnage du pH	 6 Étalonnage 7 pH	 7 90 s	 8
 9	 10	 11 Étalonnage 4 pH	 12 90 s
 13	 14	 15	 16 Enregistrer et quitter

Note : Si vous avez sélectionné «1 point cal.», L'étalonnage sera effectué uniquement en 1 point en utilisant la solution tampon 7 pH.

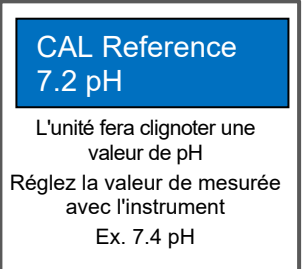
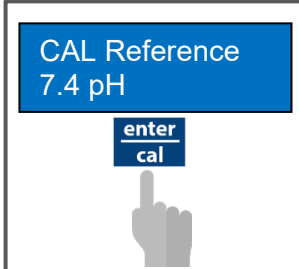
Etalonnage de référence

 <p>CAL Reference 7.2 pH</p> <p>L'unité fera clignoter une valeur de pH Réglez la valeur de mesurée avec l'instrument Ex. 7.4 pH</p>	 <p>CAL Reference 7.4 pH</p> <p> </p>
--	---

8. ÉTALONNAGE ORP

1

2

3

4

5

6

7

8

9

10

11

Définir étalonnage ORP

Étalonnage 465 mV

90 s

465 mV
Quality probe
100 %

Enregistrer et quitter

Étalonnage de référence











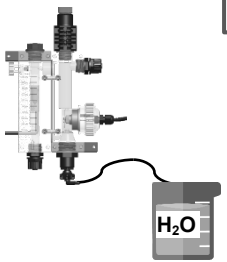
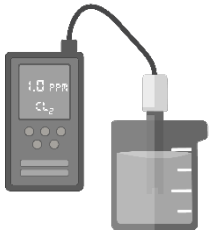

CAL Reference
720 mV

L'unité fera clignoter une valeur de redox
Réglez la valeur de mesurée avec l'instrument
Ex. 750 mV

CAL Reference
750 mV



enter
cal

9. ÉTALONNAGE CHLORE

 <p>1</p>	 <p>2</p>	 <p>3 3 s</p> <p>Sélectionner étalonnage Cl</p>	 <p>4</p>
 <p>5 10 s</p>	 <p>6</p> <p>Une valeur Cl clignote sur l'unité Définir la valeur Cl mesurée avec l'instrument Ex. 1,0 ppm de Cl libre</p>	 <p>7</p> <p>1.0 PPM</p>	 <p>8 10 s</p>
 <p>10 Fermer le débit</p>	 <p>11</p> <p>Confirmez que le flux est fermé en déplaçant le choix sur Oui et en confirmant avec CAL</p>	 <p>12 100 s</p>	 <p>13</p>
 <p>14 10 s</p>	 <p>15</p> <p>Calibrage OK !</p>		

*Appuyez sur ESC pour quitter le menu d'étalonnage.

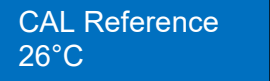
10. ÉTALONNAGE DE LA TEMPÉRATURE

 <p>10</p> <p>CAL Reference 26°C</p> <p>L'unité fera clignoter une valeur de température Réglez la valeur de température mesurée avec l'instrument Ex. 27°C</p>	 <p>11</p> <p>CAL Reference 27°C</p>
---	--

PoolDose | pH · ORP · Chlore

Menu Set

Appuyez sur **set** (3 secondes) et ajustez la valeur du point de consigne et appuyez sur **set** pour confirmer.

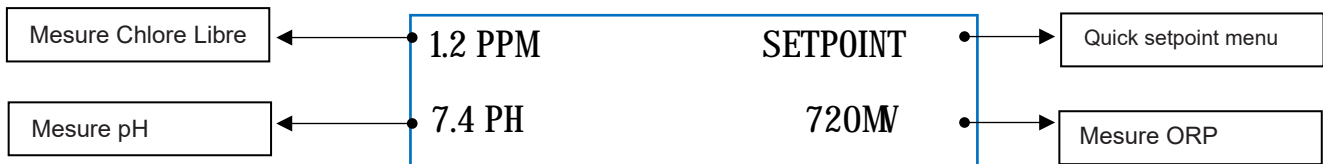

Menu d'étalonnage

Appuyez sur **enter cal** (3 secondes) et calibrer la sonde pH, Chlore, Température, ORP.

Veille

Appuyer simultanément sur les touches **▲** et **▼** pendant 5 secondes pour éteindre le rétroéclairage de l'appareil. Le dosage et l'étalonnage sont désactivés.

Réinitialisation OFA

Appuyez sur **menu esc** (3 secondes) pour réinitialiser l'alarme OFA ou appuyez sur **▲ ▼** (5 secondes) pour réinitialiser l'alarme OFA.

Amorçage

Seulement lorsque la pompe est en «mode veille», appuyez **▲** pour réinitialiser le totalisateur de débit, appuyez **▼** pour faire fonctionner la pompe de pH, appuyez sur **menu esc** pour faire fonctionner la pompe ORP / chlore, appuyez **enter cal** pour faire fonctionner le Relais Aux1, appuyez **set** pour faire fonctionner le Relais Aux2

Dosage PoolDose SPA

La régulation du pH et du chlore dans le système PoolDose Spa est gérée en maintenant la régulation du pH avant le dosage du chlore pour obtenir une meilleure régulation. Cette fonction n'est disponible que sur les produits PoolDose SPA.

Pour restaurer les paramètres par défaut, suivre les étapes ci-dessous :

- Éteindre l'unité PoolDose
- Maintenir **▲** et **▼** enfoncés et allumer l'unité
- Le message **INIT.DEFAULT** affichera à l'écran
- Sélectionnez l'unité à réinitialiser - module WiFi ou système de dosage
- Appuyer sur **▲** ou **▼** pour sélectionner **OUI** ou **NON**
- Sélectionnez **OUI** et appuyez sur **enter cal** pour restaurer les paramètres par défaut.

Paramètres par défaut :

- Langue = **EN**
- Valeur de consigne = **7,2 pH ; 700 mV ; 1,2 ppm**
- Méthode de dosage = **Acide (pH); Bas (Redox); Bas (Cl)**
- Durée OFA = **Désactivé**
- Étalonnage = **Complet**
- Admission de débit = **Désactivé (pompe de recirculation)**
- Type de dosage = **PROP ; ON/OFF Relai Aux1 et Aux2**
- EN Fréq. = **Désactivé**
- Reed = **NC (normalement fermé)**
- P.ON (Délai d'activation) = **Désactivé**
- Retard de débit = **Désactivé**

11. MÉTHODE DE DOSAGE

Point de consigne = 7,2 pH

Mode de dosage = Acide

Bande proportionnelle = 1,0 pH (* valeur non modifiable)

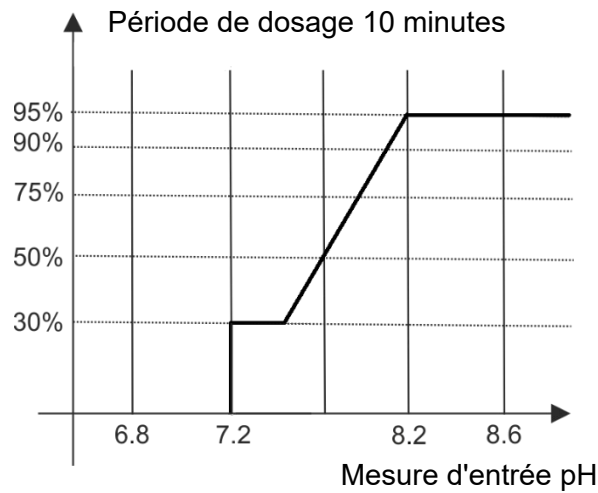

Point de consigne = 700 mV

Mode de dosage = Bas

Bande proportionnelle = 250 mV (* valeur non modifiable)

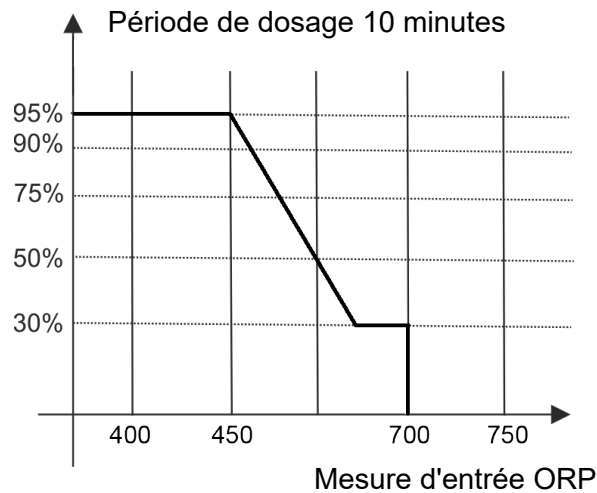

Point de consigne = 1,2ppm Chlore libre

Mode de dosage = Bas

Bande proportionnelle = 0,8ppm (* valeur non modifiable)

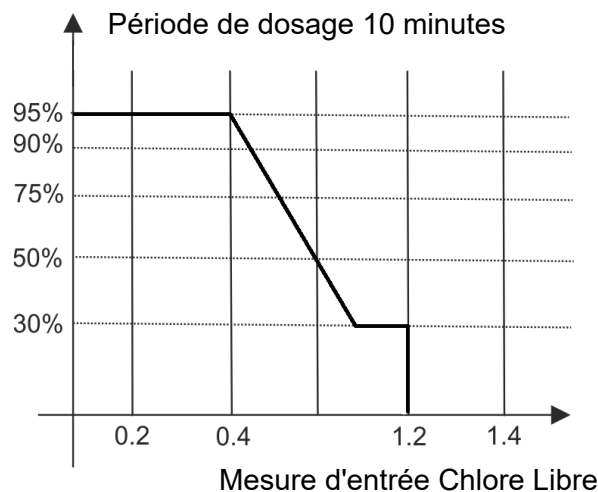

12. MÉTHODE DE DOSAGE CYCLÉ

La méthode de dosage du cycle n'est disponible que dans le modèle PoolDose SPA

Les cycles devraient être les suivants :

- 20 minutes d'attente

- 4 min de cycle de dosage en proportion pour le dosage du pH (si le pH ne nécessite pas de dosage, le

- système peut gérer la dose de Rx si nécessaire) (priorité au pH)

- 20 minutes d'attente

- 4 min de cycle de dosage en proportion pour le dosage du pH (si le pH ne nécessite pas de dosage, le

- système peut gérer la dose de Rx si nécessaire) (priorité au pH)

Exct.

Proportionnellement signifie :

Le délai est de 60 secondes :

Comme la lecture est à 90 % du point de consigne, le temps de fonctionnement est de 14 secondes

Comme la lecture est à 75 % du point de consigne, le temps de course est de 20 secondes

Comme la lecture est à 50 % du point de consigne, le temps de fonctionnement est de 30 secondes



Comme la lecture est à 25 % du point de consigne, le temps de fonctionnement est de 40 secondes

Alarme pour la valeur de consigne pH/Redox

Après avoir défini la bande d'alarme, une fenêtre de travail est créée. Si les limites autorisées sont dépassées, le relais d'alarme se ferme et reste fermé jusqu'à ce que la mesure soit réinitialisée ou qu'une pression soit exercée sur  pour désactiver l'alarme.

Après avoir défini la durée OFA (Alarme de suralimentation), la durée en temps du dosage de la valeur de consigne pH/Redox est pilotée par le biais de deux alarmes :

- Une première alarme à 70 % du temps défini est visible sur l'écran, le relais d'alarme se ferme.
- Une seconde alarme à 100 % du temps défini est visible sur l'écran, le relais d'alarme se ferme et la pompe pH/Redox est bloquée.

Appuyez sur  (3 secondes) pour réinitialiser l'alarme OFA ou appuyez sur   (5 secondes) pour réinitialiser l'alarme OFA.

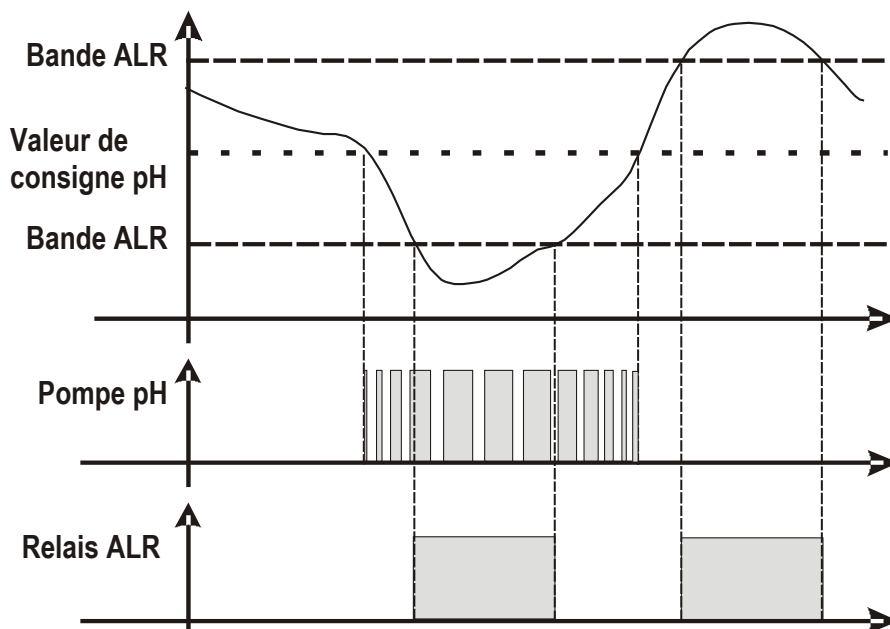

(*1 Plages pour alarmes du mesures - valeurs fixes)

n	Article	Limites
1	Temp. Mesure min	+ 10°C
2	Temp. Mesure Max	+ 38°C
3	pH Mesure min	6 pH
4	pH Mesure Max	8 pH
5	ORP Mesure min	+ 600 mV
6	ORP Mesure Max	+ 800 mV
7	CL Mesure min	0,50 ppm
8	CL Mesure Max	2 ppm

13. SERVEUR WEB INTERNE

Téléchargez l'application **SekoLink**

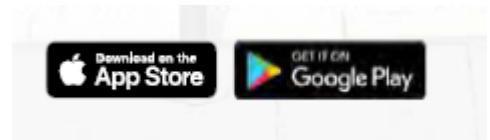

Enregistrer votre compte

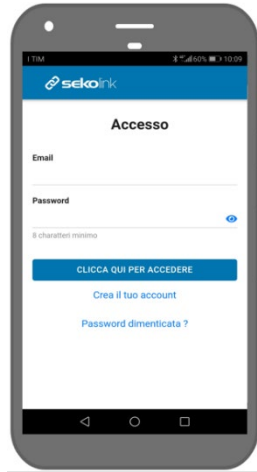

À l'aide du QR Code, connectez-vous aux pages Web internes
Définir :

Utilisateur= ADMIN
Password= 0000



Définissez le nom et le mot de passe de votre LAN WiFi et confirmez.

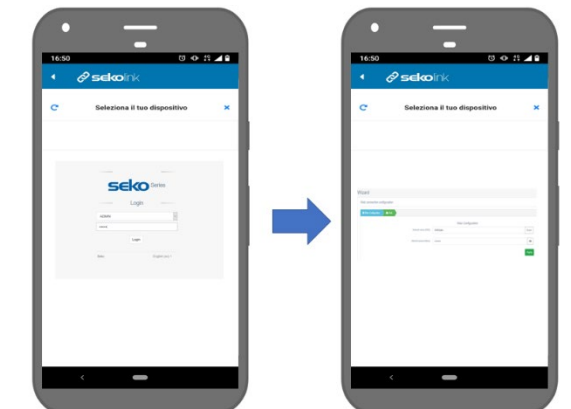

Terminez l'enregistrement de l'appareil

Grâce à votre inscription, il est possible d'utiliser gratuitement **sekolink** et **sekoweb**.



sekolink

Grâce à **sekolink**, il est possible de gérer votre piscine::

- Suivi et gestion limitée
- Application pour smartphone compatible avec iPhone ou Android
- Pour les utilisateurs finaux













sekoweb

Utilisez l'adresse **sekoweb** www.sekoweb.com ou APP pour gérer vos piscines avec un portail web professionnel::

- Suivi et gestion complète
- Portail Internet accessible via une connexion en ligne ou en scannant le code QR d'un produit
- Pour les installateurs, techniciens et ingénieurs de piscines et de spas



14. ALARMES

Alarme	Affichage	Actions à réaliser
Niveau *uniquement des mesures actives	LEV BAS	- Appuyez sur  pour ouvrir le relais d'alarme - Restaurer le réservoir de produit
Mesure hors plage	ALARMBAND	- Remplacer ou vérifier la sonde de mesure - Appuyez sur  pour ouvrir le relais d'alarme - Restaurer la mesure
Première alarme OFA (durée >70 %)	OFA_1	- Appuyez  pendant 3 secondes pour réinitialiser ou appuyez   pendant 5 secondes pour réinitialiser
Seconde alarme OFA (durée 100 %)	OFA_2	- Appuyez  pendant 3 secondes pour réinitialiser ou appuyez   pendant 5 secondes pour réinitialiser
Débit	DEBIT	- Restaurer le débit
Fonction d'étalonnage	ERREUR CALIBRAGE	- Restaurez la sonde ou la solution tampon et répétez la procédure d'étalonnage
Erreur système	ERREUR PARAMETRE	- Appuyez sur  pour restaurer le paramètre par défaut - Unité cassée
Alarme mesure (*1)	MESURE ELEVEE MESURE BASSE	- Ajustez la concentration chimique
Le menu WiFi n'est pas présent dans le menu avancé, mais la carte WiFi est présente	LE MENU WI-FI NEST PAS PRESENT	- Éteignez l'appareil, maintenez appuyé  et allumez.
Mesure d'erreur	MAUVAISE MESURE	- Veuillez réinitialiser le paramètre d'étalonnage, dans le menu avancé, cliquez sur Réinitialiser l'élément CAL.

(*1 Plages pour alarmes du mesures)

n	Article	Limites
1	Temp. Mesure min	+ 10°C
2	Temp. Mesure Max	+ 38°C
3	pH Mesure min	6 pH
4	pH Mesure Max	8 pH
5	ORP Mesure min	+ 600 mV
6	ORP Mesure Max	+ 800 mV
7	CL Mesure min	0,50 ppm
8	CL Mesure Max	2 ppm

15. MANUTENTION

Remplacement du tuyau :

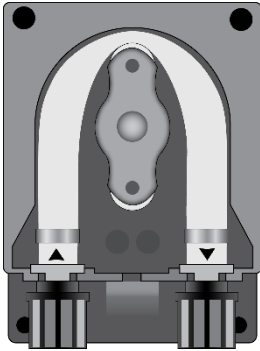

Ouvrir le couvercle de la pompe et libérer le tuyau en tirant sur le connecteur gauche vers le haut.

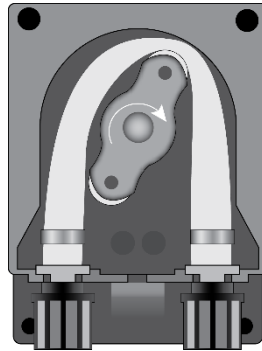

Placer le rouleau à 7h05, en le tournant dans le sens de la flèche circulaire.

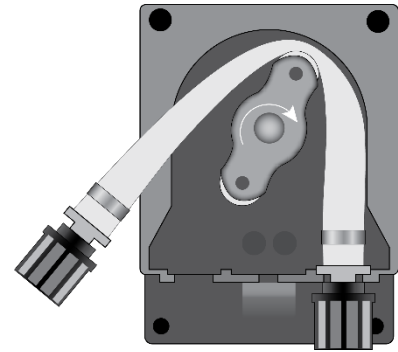

Libérer complètement le connecteur gauche, en le maintenant tendu vers l'extérieur, et tourner le rouleau dans le sens de la flèche circulaire de sorte que le tuyau soit libéré du connecteur droit.

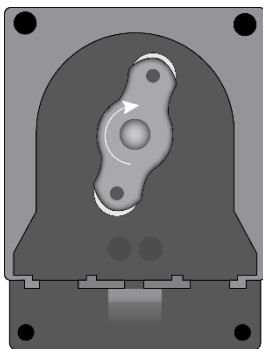

Placer le rouleau à 7h05, en le tournant dans le sens de la flèche circulaire.

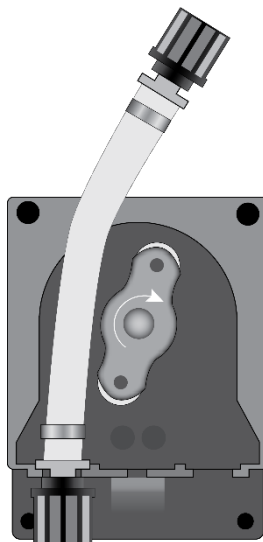

Insérer le connecteur gauche dans le boîtier correspondant et faire passer le tuyau sous le guide du rouleau. Tourner le rouleau dans le sens de la flèche circulaire, en accompagnant simultanément le tuyau dans la tête de la pompe, jusqu'à atteindre le connecteur droit.

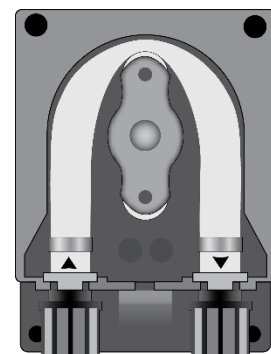

Fermer le couvercle de la pompe et appuyer fermement sur sa surface pour qu'elle soit correctement verrouillée en place.

*Procédure de remplacement du tube valable pour 2 et 3 rouleaux.

16. STOCKAGE DE LA POMPE APRÈS UTILISATION

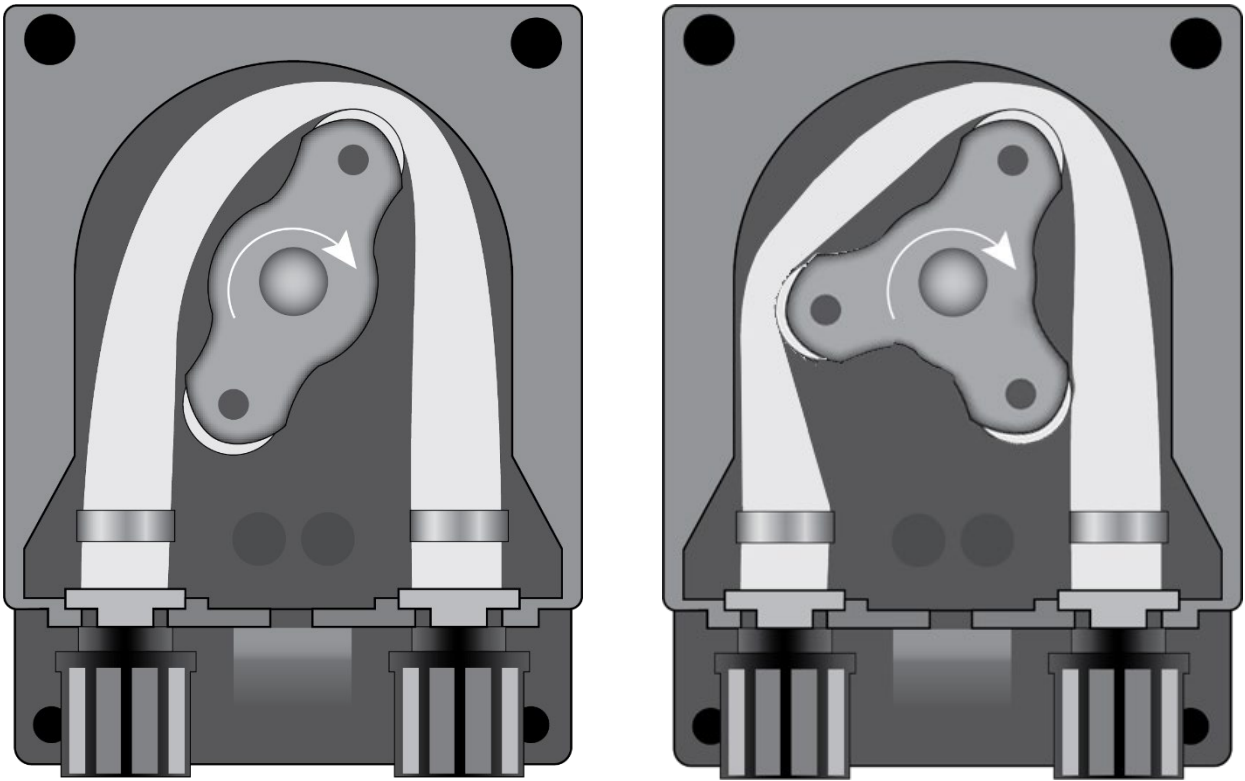

Lorsque le dispositif de régulation doit être rangé, pompez de l'eau propre à travers le tuyau afin de le rincer. Puis, placez le rouleau à 7h05, en le tournant dans le sens de la flèche circulaire. Ces deux précautions faciliteront la réactivation ultérieure de l'unité.

PoolDose | pH · ORP · Chlore

Connexions de fils :

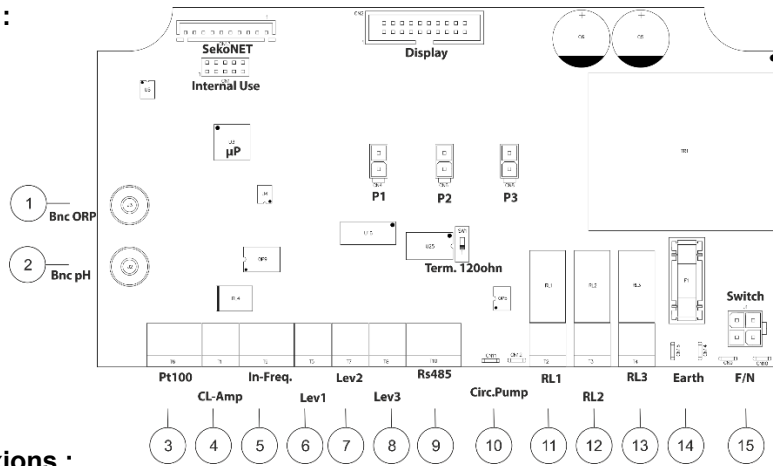

Étiquette de connexions :

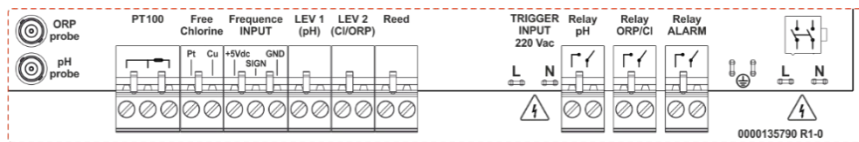

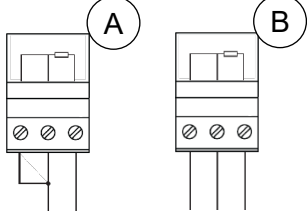
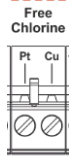
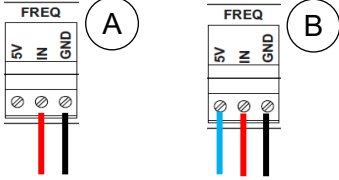
Serrage	Description	PoolDose pH · ORP	
1	Sonde d'entrée	ORP	ORP Probe
2	Sonde d'entrée	pH	pH Probe
3	Sonde d'entrée	TEMP (PT100) A= capteur à deux fils B= capteur à trois fils	
4	Entrée sonde de chlore libre	Entrée sonde de chlore libre: Pt: Capteur en platine Cu: Capteur en cuivre	
5	Entrée signal fréq.	Débit (entrée fréq.) A= Reed mécanique B= Capteur Hall Padwheel	
6	Niveau (réservoir de produit)	Sonde de niveau pH	Sonde de niveau réservoir de produit chimique
7	Niveau (réservoir de produit)	Sonde de niveau Chlore (ORP)	Sonde de niveau réservoir de produit chimique
8	Niveau (réservoir de produit)	Débit (capteur REED)	Capteur débit
9	Port série	Pas présent	Aucun
10	Entrée de déclenchement	Pompe de circulation (entrée 220Vac)	Fils Phase / Neutre
11	Relais de sortie	RL1 AUX1 pH	Contact sec
12	Relais de sortie	RL2 AUX2 OPR/Chlore	Contact sec
13	Relais de sortie	RL3 Alarme	Contact sec
14	Connecteur de terre	Terre	---
15	Alimentation électrique	220-240 Vac 50-60 Hz (F/N)	---



AVVERTENZA!

Prima di effettuare QUALSIASI operazione all'interno del pannello di controllo del dispositivo PoolDose, assicurarsi di averlo scollegato dalla rete di alimentazione.

Il mancato rispetto delle istruzioni contenute nel presente manuale può causare lesioni a persone e/o danni al dispositivo e al sistema.

1. CONTENUTO DELLA CONFEZIONE

A: Tubo di aspirazione PVC Crystal 4x6 (4m)	B: Tubo di mandata in polietilene (5 m)	C: Valvola a labbro FPM (3/8" GAS)	D: Porta sonda PSS3 (1/2" GAS)	E: Staffa per fissaggio del PSS3 sul tubo da 2" (φ=50 mm)	F: Riduttore per valvola di iniezione (1/2" M - 3/8" F)
G: Filtro di fondo (montante in PP)	H: Kit staffe di montaggio (φviti da 6 mm)	L: Sensore di temperatura	M: sonda pH	N: Sonda Redox	O: Porta sonda + sonda del cloro
P: Filtro Minor (5") + Porta sonda PSS3 (1/2" GAS)	Q: Spazzola per sonda del cloro	R: Sfere per sonda del cloro	S: Soluzione tampone pH 4	T: Soluzione tampone pH 7	U: Soluzione di calibrazione 465 mV
V: Acqua					

Componente *	Sistema	Sistema a doppia pompa	
		PoolDose pH / ORP	PoolDose pH / ORP / CL
A		2	2
B		2	2
C		2	2
D		2	-
E		4 ^(*1)	4 ^(*1)
F		2	2
G		2	2
H		1	1
L		1 ^(*2)	1 ^(*2)
M		1	1
N		1	1
O		-	1
P		-	1
Q		-	1
R		-	1
S		1	1
T		1	1
U		1	1
V		1	1

* I valori riportati nella tabella rappresentano il numero di componenti contenuti nella confezione.

(*1 Cinque pezzi solo per il modello WiFi)

(*2 Un pezzo solo per il modello WiFi)

PoolDose | pH · ORP · Cloro

AVVERTENZA!

Questi prodotti sono **PERICOLOSI (I✳A)** e richiedono precauzioni speciali durante l'uso, la manipolazione e lo stoccaggio.

- **Non miscelare MAI i prodotti chimici.**
- Non permettere MAI a bambini o a persone che non abbiano letto il presente manuale di utilizzare o manomettere PoolDose o i suoi componenti periferici (inclusi i prodotti chimici).

Prodotti chimici pH:

- **ASSOLUTAMENTE** sconsigliato => acido solforico puro
- Consigliato per abbassare il pH => pH negativo (con una base di acido solforico)
- Consigliato per aumentare il pH => pH positivo (carbonato o bicarbonato di sodio)

Prodotti chimici Redox:

- **ASSOLUTAMENTE** sconsigliato => tutti i tipi di cloro organico
- È possibile utilizzare cloro liquido o candeggina a 12% puri. Se la concentrazione del prodotto è di 48%, sarà necessario diluirlo in acqua con un rapporto di 1:3.

Le sonde pH / Redox sono soggette a usura e pertanto non sono coperte dalla garanzia.

2. ISTRUZIONI PER L'INSTALLAZIONE

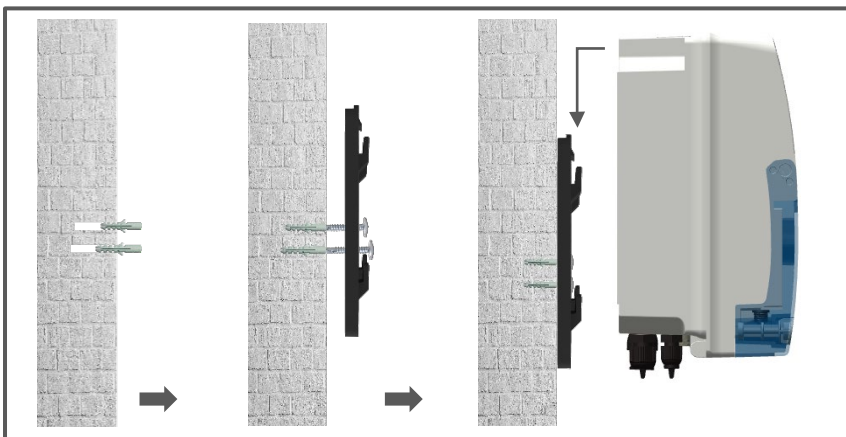

Verificare che la pressione di iniezione sia inferiore a 1,5 bar

Posizionamento della sonda



Per una lettura ottimale della sonda, posizionarla perpendicolarmente al tubo.



L'angolo di inclinazione della sonda non deve mai essere superiore a 45° dalla verticale.



Impianto di installazione



Avvertenza!

Usare con generatore di cloro a sale:

Per evitare rischi di malfunzionamento o danneggiamento dei sistemi pH, rispettare le istruzioni riportate di seguito:

1. Posizionare la sonda di misurazione del pH prima della cella del generatore di cloro.
2. Per eliminare le eventuali correnti parassite, collegare l'acqua della piscina a una massa elettrica.
3. Collocare il punto di iniezione del prodotto dopo la cella del generatore di cloro.

3. COLLEGAMENTI ELETTRICI

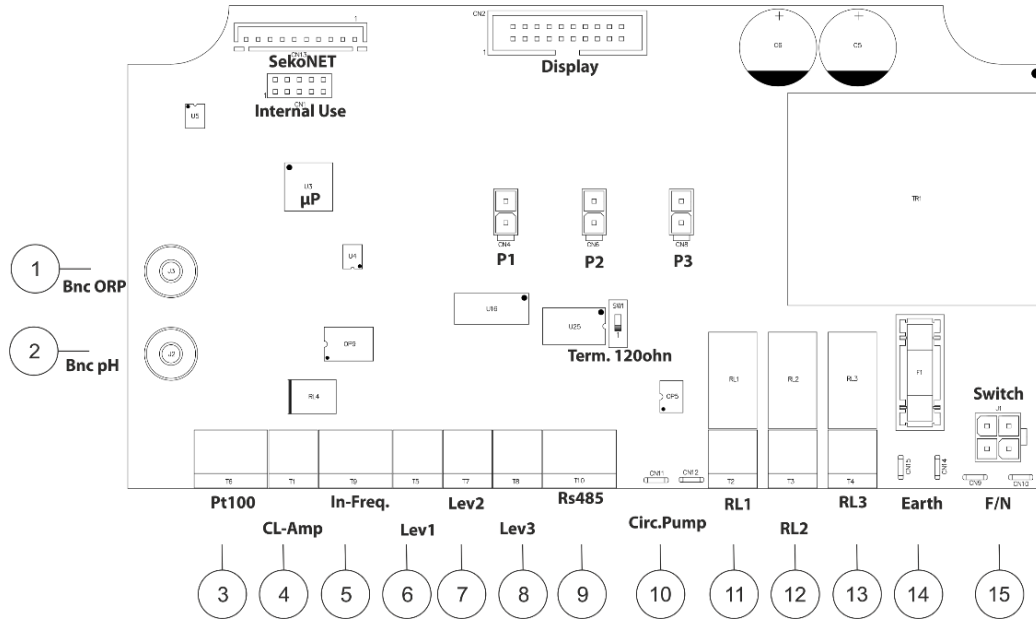

Morsetto	Descrizione	Sistema a doppia pompa	
		PoolDose pH · ORP	PoolDose pH · ORP · CL
1	Ingresso sonda	ORP	ORP
2	Ingresso sonda	pH	pH
3	Ingresso sonda	TEMP (PT100)	TEMP (PT100)
4	Ingresso sonda	Non usato	Cloro libero
5	Ingresso segnale freq.	Portata (Ingresso freq.)	Portata (Ingresso freq.)
6	Livello (serbatoio prodotto)	Sonda livello pH	Sonda livello pH
7	Livello (serbatoio prodotto)	Sonda livello Cloro (ORP)	Sonda livello Cloro
8	Livello (sensore di flusso Reed esterno)	Flusso (sensore REED)	Flusso (sensore REED)
9	Porta seriale	Non presente	Non presente
10	Ingresso trigger 220Vac (alta tensione)	Pompa di ricircolo (Ingresso 220Vac)	Pompa di ricircolo (Ingresso 220Vac)
11	Relè di uscita R1	RL1 AUX1 pH	RL1 AUX1 pH
12	Relè di uscita R2	RL2 AUX2 OPR/ Cloro	RL2 AUX2 OPR/ Cloro
13	Relè di uscita R3	RL3 Allarme	RL3 Allarme
14	Connettore di terra	Terra	Terra
15	Alimentazione	220-240 Vac 50-60 Hz (F/N)	220-240 Vac 50-60 Hz (F/N)
P1	Collegamento pompa peristaltica	pH	pH
P2	Collegamento pompa peristaltica	Cloro (ORP)	Cloro
P3	Collegamento pompa peristaltica	Non usato	Non usato
SekoNet	Modulo WiFi	Scheda WiFi (codice dedicato)	Scheda WiFi (codice dedicato)

Etichetta connessioni

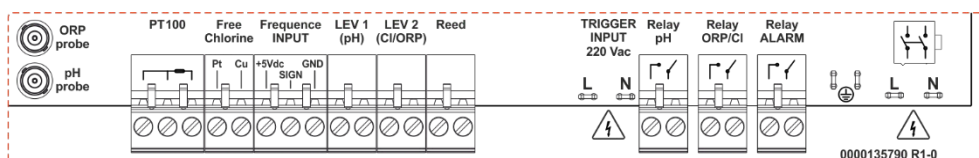

4. SPECIFICHE TECNICHE

Specifiche	PoolDose Double PH/ORP	PoolDose Double PH/ORP/Cloro
Dimensioni (A-L-P)	A:194,5 x L:205,1 x P:132,8 mm	A:194,5 x L:205,1 x P:132,8 mm
Peso	3,5 Kg	3,5 Kg
Stato pompa	Pausa - Alimentazione	Pausa - Alimentazione
Calibrazione della sonda	Automatica	Automatica
Alimentazione	220-240 VAC 50-60 Hz	220-240 VAC 50-60 Hz
Consumo (W)	28 Watt	28 Watt
Precisione del dispositivo	± 0,1 pH; ±10mV; ±1°C	± 0,1 pH; ±10mV; 0,1 ppm; ±1°C
Accuratezza	±0,02pH, ±3mV; ±0,5°C	±0,02pH, ±3mV; 0,05 ppm; ±0,5°C
Intervallo	0-14pH; -99 -1000mV; 0...+55°C	0-14pH; -99 -1000mV; 0-5 ppm; 0...+55°C
Portata della pompa (l/h)	1,5 l/h	1,5 l/h
Portata della pompa (solo modello SPA)	0.4 l/h	Non disponibile
Contropressione max.	1,5bar	1,5bar
Contatto relè (numero 3)	250 Vac 10A (carico resistivo)	250 Vac 10A (carico resistivo)
Fusibile	500 mA (veloce)	500 mA (veloce)

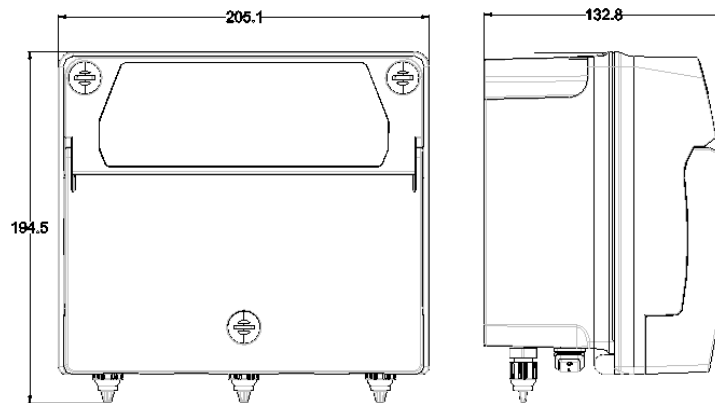

5. DISPOSITIVO DI SOPPRESSIONE ELETTRICA

È obbligatorio installare il soppressore della bobina, seguire la procedura di istruzione:

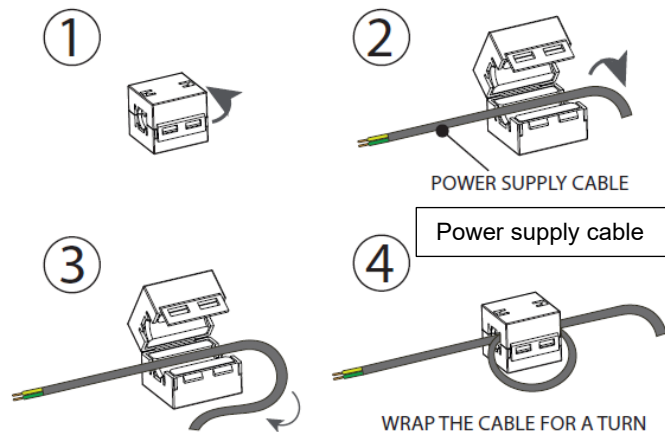

6. ISTRUZIONI DI CONFIGURAZIONE DEL SISTEMA

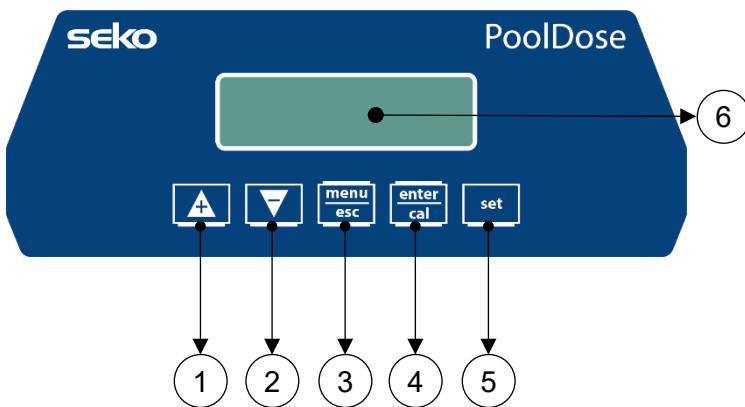

- 1) Pulsante per aumentare il valore
- 2) Pulsante per ridurre il valore
- 3) Pulsante Menu/Esc
- 4) Pulsante Cal/OK
- 5) Pulsante di impostazione del Setpoint
- 6) Display digitale

Configurazione del programma – Premere **menu esc** per 5 secondi

Accedendo ad ogni voce del menu, è possibile modificare direttamente il parametro con i tasti freccia (**▲** e **▼**). Per confermare l'impostazione attuale e passare alla voce successiva, premere il tasto **enter cal**.

Il menu è dotato di una struttura circolare: una volta arrivati all'ultima voce, quando si conferma il parametro impostato, premendo **enter cal** si torna alla prima voce.

1 LINGUA – È possibile selezionare tra 5 lingue disponibili: **EN**, **FR**, **IT**, **DE**, **ES**

2 PH

- **SETPOINT** – **7,2pH** (6-8pH)
- **TIPO SETPOINT:** – **Acido** (Acido/Alcalino)

* Solo dosaggio temporizzato

- **TIME ON** = (Tempo avvio) 30 secondi (intervallo da 1 a 360 secondi)
- **TIME OFF** = (Tempo arresto) 60 secondi (intervallo da 1 a 360 secondi)
- **TEMPERATURA:** 25°C; impostare °C/°F e valore manuale
- **ALLARME OFA:** Off, 1-60' (minuti)

3 ORP

- **SETPOINT** – **700 mV** (400-850mV)
- **TIPO SETPOINT:** **Basso** (Basso/Alto)

* Solo dosaggio temporizzato

- **TIME ON** = (Tempo avvio) 30 secondi (intervallo da 1 a 360 secondi)
- **TIME OFF** = (Tempo arresto) 60 secondi (intervallo da 1 a 360 secondi)
- **ALLARME OFA:** Off, 1-60' (minuti)

▪ **Nota:** Il dosaggio ORP (redox) in presenza del cloro, non ha effetto sulla pompa dosatrice, ma può gestire il Relè Aux2 con attivazione ON/OFF rispetto al Setpoint.

4 CLORO

- **SETPOINT** – **1,2 ppm**(0.3-3.0 ppm)
- **TIPO SETPOINT:** **Basso** (Basso/Alto)

* Solo dosaggio temporizzato

- **TIME ON** = (Tempo avvio) 30 secondi (intervallo da 1 a 360 secondi)
- **TIME OFF** = (Tempo arresto) 60 secondi (intervallo da 1 a 360 secondi)
- **ALLARME OFA:** Off, 1-60' (minuti)

5 MENU AVANZATO

- **POMPA DI RICIRCOLO** – (Abilitato/ Disabilitato)
- **IN FREQ** (Ingresso portata)
 - OFF/ON
 - Impulso/Litro:1 o Litro/Impulso:1 – Impostare valore
 - Unità di misura: L o m³
- **CALIBRAZIONE PH:** 2 punti, 1 punto, Riferimento, Disabilitato
- **CALIBRAZIONE ORP:** 1 punto, Riferimento, Disabilitato

- CALIBRATION CL: 2 points, Disable,
- CALIBRATION TEMP: Reference, Disable,
- DOSING TYPE PH: Proporzionale, OFF, **CYCLE**, Timed, On/OFF
- **Nota:** Modalità di dosaggio del ciclo, è presente solo nell'applicazione PoolDose SPA. DOSING TYPE ORP: Proporzionale, OFF, **CYCLE**, Timed, On/OFF,
 - **Nota:** il dosaggio ORP è disabilitato se il **tipo di dosaggio del cloro** è diverso da OFF
- **Nota:** Modalità di dosaggio del ciclo, è presente solo nell'applicazione PoolDose SPA. TIPO DOSAGGIO CLORO: Proporzionale, OFF, Temporizzato, On/OFF
- RELE AUX
 - RELE AUX1: pH, Disabilitato
 - RELE AUX2: Cloro, ORP, Disabilitato
 - **Nota:** i rele Aux1 e Aux2 dosano con metodo ON/OFF
- PASSWORD: 0000 (**Nota:** password disabilitata, impostare un valore diverso da: 0000)
- RESET CALIBRAZIONE: (**Nota:** selezionare la misura da resettare: pH; Cloro; ORP)
- RESET TUTTI I PARAMETRI: ripristina i parametri predefiniti
- CONTROL PANEL: visualizza i segnali elettrici
- WFI CONFIGURAZIONE
 - Nome rete WiFi
 - Password WiFi
 - Indirizzo IP rete WiFi.

Nota: Questo menu è disponibile solo nel prodotto WiFi, non è presente nell'applicazione PoolDose SPA.

- REED (errore di visualizzazione in rosso): NO/NC
- POWER ON DELAY: (Ritardo accensione) Disabilita le pompe dosatrici per il tempo impostato (OFF...1:90 minuti)
- FLOWDELAY: (Ritardo flusso) Disabilita le pompe dosatrici per il tempo impostato (OFF...1:60 minuti)

Nota: Timeout per il menu di impostazioni - dopo 120 secondi senza azione il controller esce da solo senza salvare i parametri.

Esempio di visualizzazione

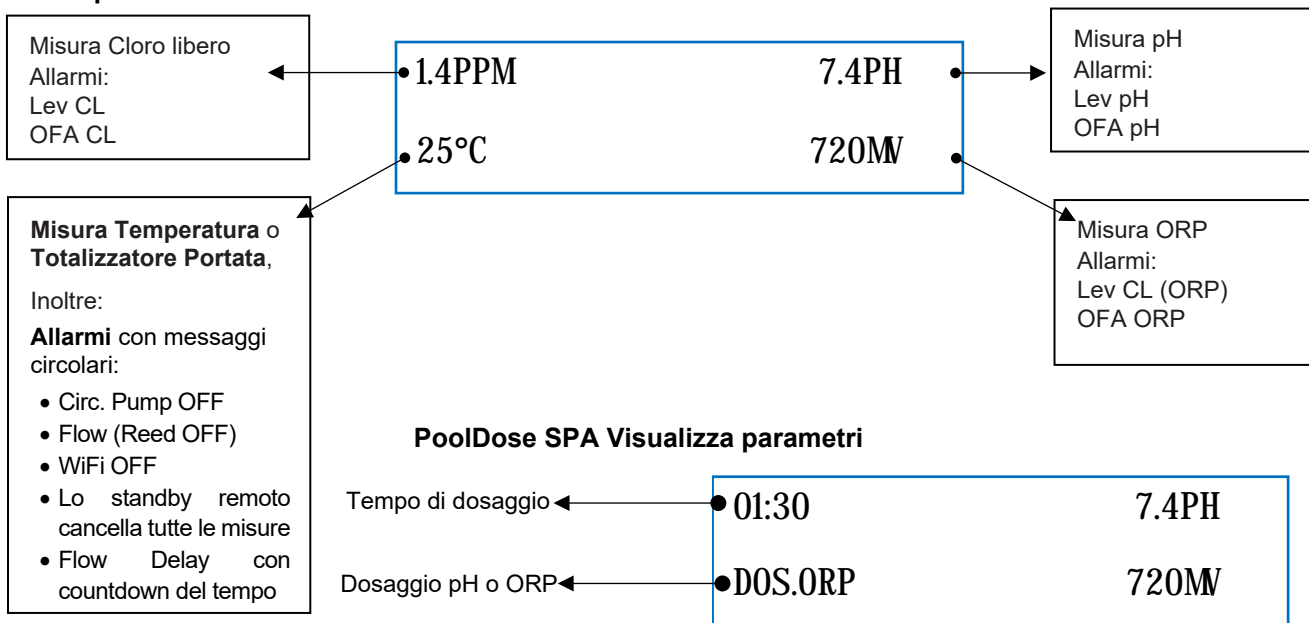





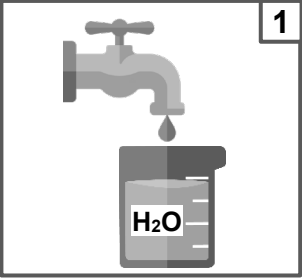
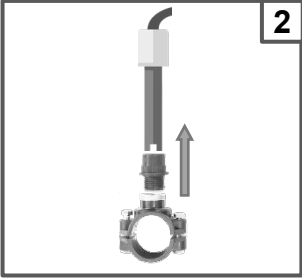
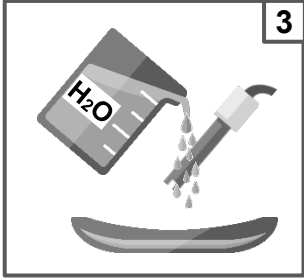
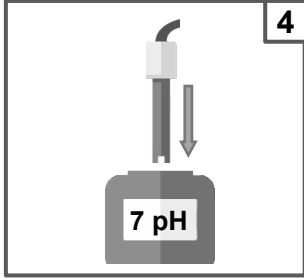
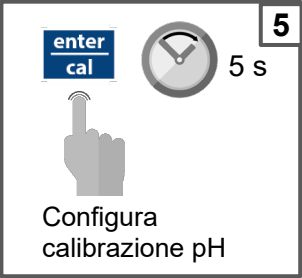
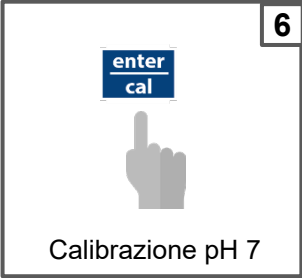
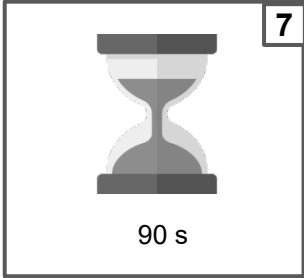

PoolDose | pH · ORP · Cloro

Menu di calibrazione:

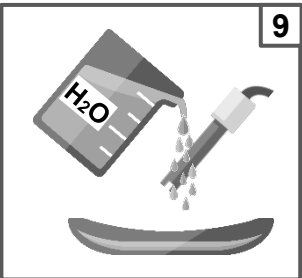
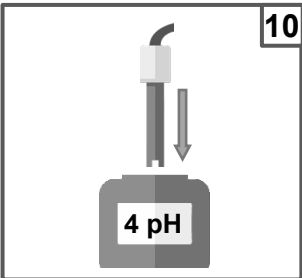
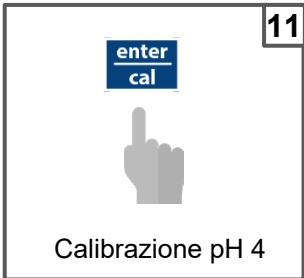
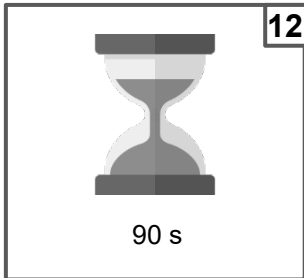
Premere **enter cal** (3 secondi) per calibrare la sonda di pH, Cloro, Temperatura, ORP

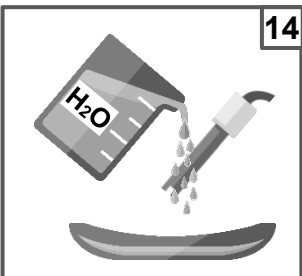
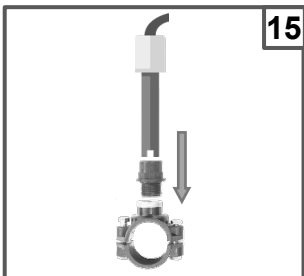
7. CALIBRAZIONE pH

 1	 2	 3	 4
 5 Configura calibrazione pH	 6 Calibrazione pH 7	 7 90 s	 8
 9	 10	 11 Calibrazione pH 4	 12 90 s
 13	 14	 15	 16 Salva ed esci

Nota: Selezionando la funzione “1 punto cal.”, la calibrazione verrà effettuata solo in 1 punto utilizzando la soluzione tampone con pH 7.

Calibrazione di riferimento

CAL Riferimento
7.2 pH







L'unità lampeggerà un valore di pH
Impostare il valore di misurato con lo strumento
Es. 7.4 pH

CAL Riferimento
7.4 pH

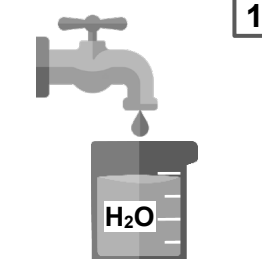
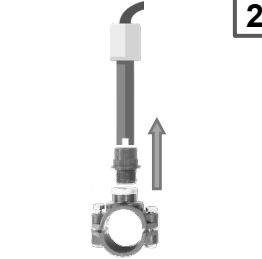
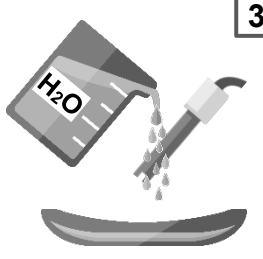
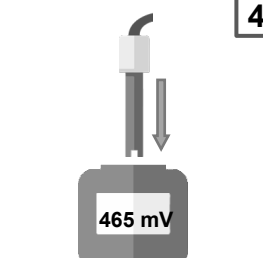
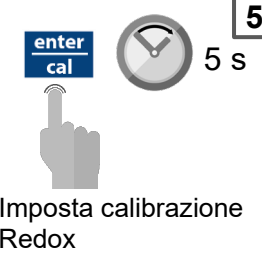
enter cal

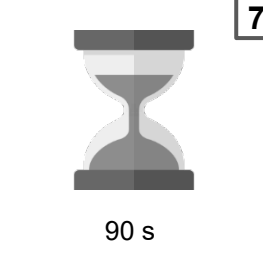

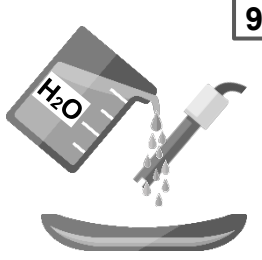
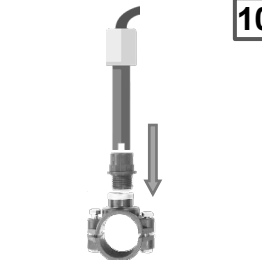
8. CALIBRAZIONE REDOX

 <p>1</p>	 <p>2</p>	 <p>3</p>	 <p>4</p>
 <p>5</p> <p>enter cal 5 s</p> <p>Imposta calibrazione Redox</p>	 <p>6</p> <p>enter cal</p> <p>Calibrazione 465 mV</p>	 <p>7</p> <p>90 s</p>	 <p>8</p> <p>465 mV Qualità sonda 100%</p>
 <p>9</p>	 <p>10</p>	 <p>11</p> <p>enter cal</p> <p>Salva ed esci</p>	

Calibrazione di riferimento

<p>CAL Riferimento 720 mV</p> <p>L'unità lampeggerà un valore di Redox Impostare il valore di misurato con lo strumento Es. 750 mV</p>	<p>CAL Riferimento 750 mV</p>  <p>enter cal</p>
---	---

9. CALIBRAZIONE CLORO

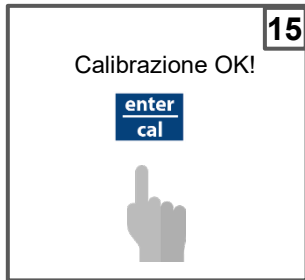
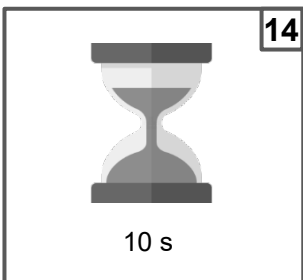
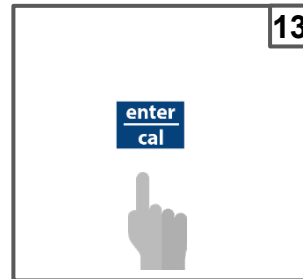
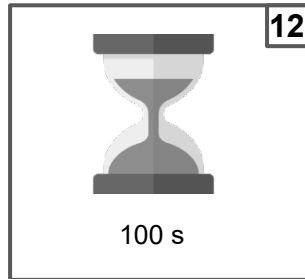
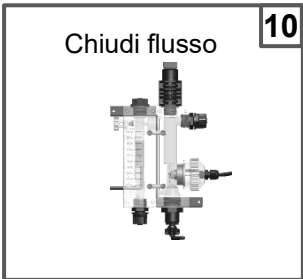
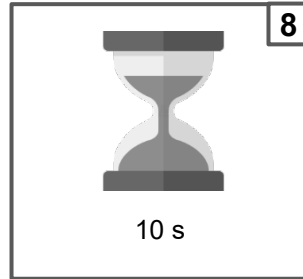
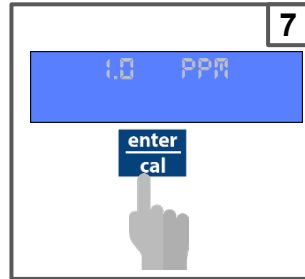
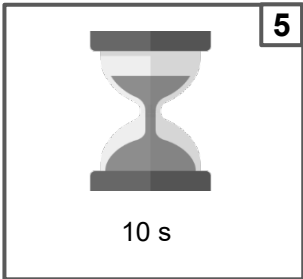
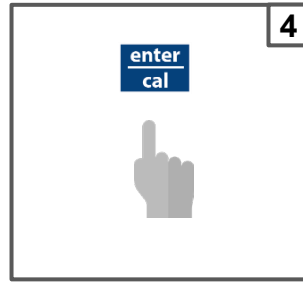
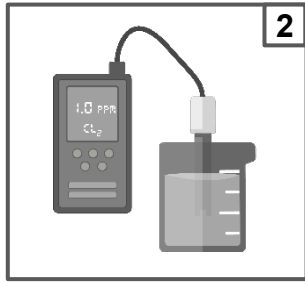
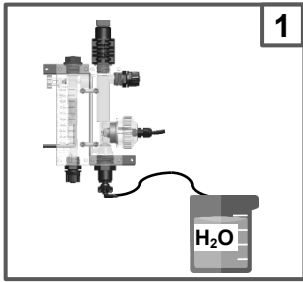

*Premere ESC per uscire dal menu di calibrazione.

10. CALIBRAZIONE TEMPERATURA



PoolDose | pH · ORP · Cloro

Menu impostazioni

Premere **set** (3 secondi) per regolare il valore del Setpoint e premere **set** per confermare.

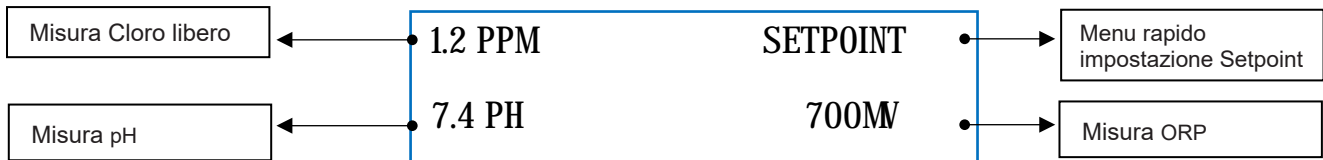

Menu di calibrazione

Premere **enter cal** (3 secondi) per calibrare la sonda pH, Cloro, Temperatura, ORP

Modalità StandBy

Premere **▼ ▲** (5 secondi) il sistema va in modalità StandBy, tutte le funzioni sono disabilitate.

Reset Timer OFA

Premere **menu esc** (3 secondi) per ripristinare l'allarme OFA o premere **▲ ▼** (5 secondi) per ripristinare l'allarme OFA.

Adescamento pompe

Solo con la pompa in "modalità stand-by" premere **▲** per azzerare il totalizzatore di flusso, premere **▼** per far funzionare la pompa pH, premere **menu esc** per far funzionare la pompa ORP/Cloro, premere **enter cal** per far funzionare il Relè Aux1, premere **set** per far funzionare il Relè Aux2.

Dosaggio PoolDose SPA

La regolazione del pH e del cloro nel sistema PoolDose Spa è gestito mantenendo la regolazione del pH prioritaria al dosaggio del cloro per ottenere una migliore regolazione. Questa funzione è disponibile solo sui prodotti PoolDose SPA.

Per ripristinare i parametri predefiniti, procedere come indicato di seguito:

- Spegnere l'unità PoolDose
- Tenere **▲** e **▼** premuti e accendere l'unità
- L'unità visualizzerà **INT.DEFAULT**
- Selezionare l'unità da ripristinare: modulo WiFi o sistema di dosaggio
- Premere **▲** o **▼** per selezionare **SI** o **NO**
- Selezionare **SI** e premere **enter cal** per ripristinare i parametri predefiniti.

Parametri predefiniti:

- Lingua = **EN**
- Valore di Setpoint = **7,2 pH; 700 mV; 1,2 ppm**
- Metodo di dosaggio = **Acido (pH); Basso (Redox); Basso (Cl)**
- Tempo OFA = **OFF**
- Calibrazione = **Full**
- Ingresso flusso = **OFF (pompa di ricircolo)**
- Tipo di dosaggio = **PROP; ON/OFF Relè Aux1 e Aux2**
- IN Freq. = **OFF**
- Reed = **NC (normalmente chiuso)**
- P.ON (Ritardo accensione) = **OFF**
- Ritardo flusso = **OFF**

11. METODO DI DOSAGGIO

Setpoint = 7,2 pH

Modalità di dosaggio = Acido

Banda Proporzionale = 1,0 pH (* Valore fisso)

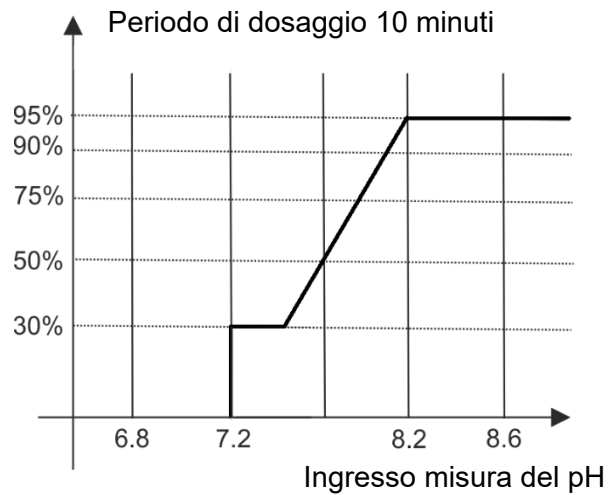

Setpoint = 700 mV

Modalità di dosaggio = Bassa

Banda Proporzionale = 250mV (* Valore fisso)

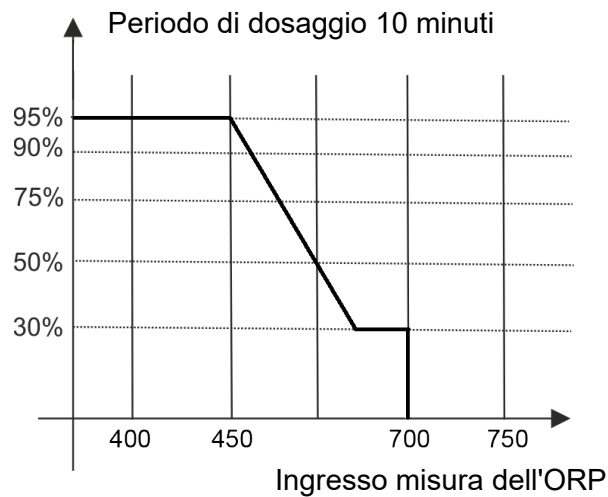

Setpoint = 1,2ppm Cloro libero

Modalità di dosaggio = Bassa

Banda Proporzionale = 0,8ppm (* Valore fisso)

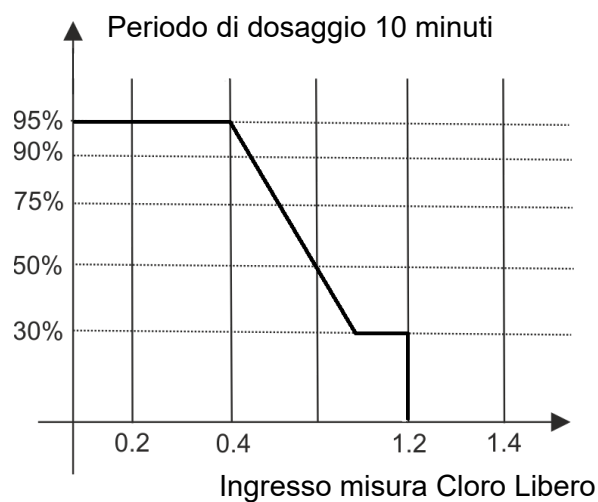

12. METODO DI DOSAGGIO DEL CICLO

Il metodo di dosaggio del ciclo è disponibile solo nel modello PoolDose SPA

I cicli dovrebbero essere i seguenti:

- 20 minuti di attesa

- 4 minuti di ciclo di dosaggio in proporzione per il dosaggio del pH (se il pH non richiede il dosaggio, il

- il sistema può gestire il dosaggio per Rx se necessario) (priorità al pH)

- 20 minuti di attesa

- 4 minuti di ciclo di dosaggio in proporzione per il dosaggio del pH (se il pH non richiede il dosaggio, il

- il sistema può gestire il dosaggio per Rx se necessario) (priorità al pH)

Exct.

Proporzionalmente significa:

L'intervallo di tempo è di 60 secondi:

Poiché la lettura è al 90% del setpoint, il tempo di esecuzione è di 14 secondi

Poiché la lettura è al 75% del setpoint, il tempo di esecuzione è di 20 secondi

Poiché la lettura è al 50 % del setpoint, il tempo di esecuzione è di 30 secondi

Poiché la lettura è al 25% del setpoint, il tempo di esecuzione è di 40 secondi

Allarme per il Setpoint pH/Redox

Quando si definisce una banda di allarme, viene creata una finestra di lavoro. Se i limiti consentiti vengono superati, il relè di allarme si chiude e rimane chiuso fino a quando la misurazione non viene azzerata o non viene premuto  per disattivare l'allarme.

Una volta configurato il parametro OFA time (Tempo OFA - Over Feed Alarm), il tempo di dosaggio del Setpoint pH/Redox viene controllato attraverso due allarmi:

- Quando il primo, impostato al 70% del tempo predefinito, viene visualizzato sul display, il relè di allarme si chiude.
- Quando invece sul display viene visualizzato il secondo allarme, impostato al 100% del tempo predefinito, il relè di allarme si chiude e la pompa pH/Redox viene bloccata.

Premere  (3 secondi) per ripristinare l'allarme OFA o premere   (5 secondi) per ripristinare l'allarme OFA.

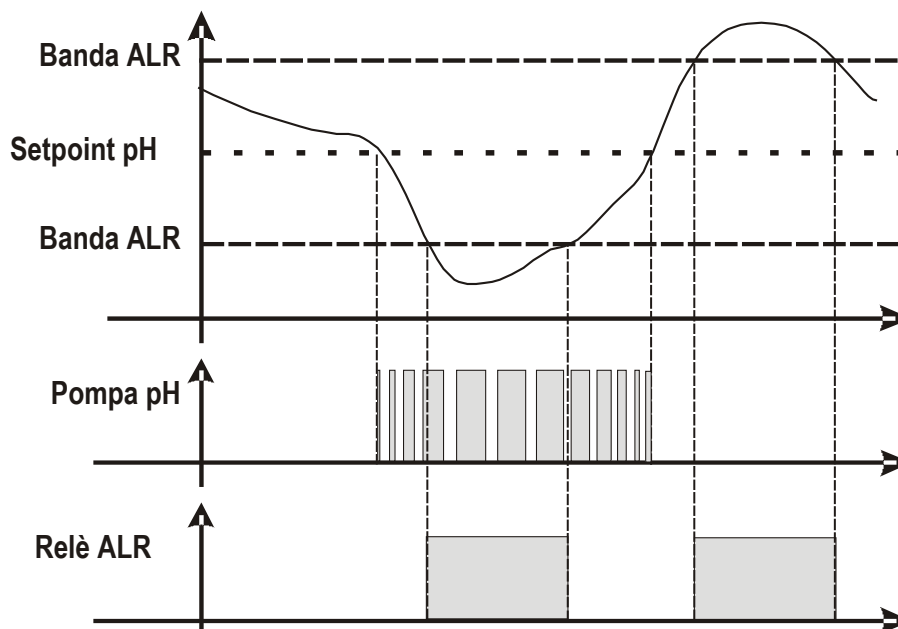

(*1 Intervalli misure allarmi – valori fissi)

n	Item	Limiti
1	Misura Temp. min	+ 10°C
2	Misura Temp. Max	+ 38°C
3	Misura pH min	6 pH
4	Misura pH Max	8 pH
5	Misura ORP min	+ 600 mV
6	Misura ORP Max	+ 800 mV
7	Misura CL min	0,50 ppm
8	Misura CL Max	2 ppm

13. SERVER WEB INTERNO

Scaricare l'applicazione **SekoLink**

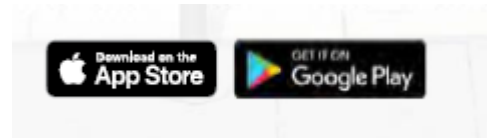

Registrare il tuo account

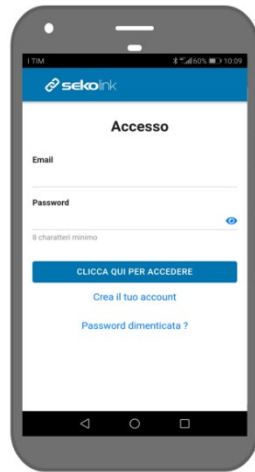

Grazie al Qr Code collegarsi alle pagine interne del prodotto
Impostare:

User name = ADMIN
Password= 0000



Impostare il nome della WiFi LAN e Password locale.

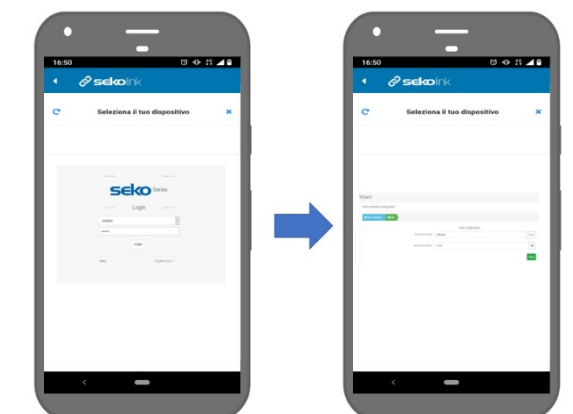

Completa la registrazione del prodotto in rete seguendo i passi della APP.

PoolDose | pH · ORP · Cloro

Grazie alla registrazione è possibile usare la APP **sekolink** e portale **sekoweb**.



sekolink

Grazie alla APP **sekolink** è possibile controllare la tua piscina:

- Monitoraggio con gestione limitata
- App per smartphone compatibile con iPhone o Android
- Per gli utenti finali

















sekoweb

Usa il link di **sekoweb** www.sekoweb.com o l'APP l'APP per gestire le tue piscine con un portale web professionale:

- Monitoraggio con gestione completa
- Portale Internet accessibile tramite login in linea o scansionando il codice QR di un prodotto
- Per installatori, tecnici e ingegneri di piscine e spa



14. ALLARMI

Allarme	Display	Azioni da eseguire
Livello *solo misure attive	LIVBASSO	<ul style="list-style-type: none"> - Premere  per 3 secondi per ripristinare o premere   per 5 secondi per ripristinare - Ripristinare il serbatoio prodotto
Misura fuori intervallo	ALARMBAND	<ul style="list-style-type: none"> - Sostituire o controllare la sonda di misura - Premere  per 3 secondi per ripristinare o premere   per 5 secondi per ripristinare - Ripristinare la misura
Primo allarme OFA (tempo >70%)	OFA_1	<ul style="list-style-type: none"> - Premere  per 3 secondi per ripristinare o premere   per 5 secondi per ripristinare
Secondo allarme OFA (tempo >100%)	OFA_2	<ul style="list-style-type: none"> - Premere  per 3 secondi per ripristinare o premere   per 5 secondi per ripristinare
Portata	FLUSSO	<ul style="list-style-type: none"> - Ripristinare la portata
Funzione di calibrazione	ERRORE CALIBRAZ.	<ul style="list-style-type: none"> - Ripristinare la soluzione Sonda o Tampone e ripetere la procedura di calibrazione
Errore del sistema	ERRORE PARAMETRI	<ul style="list-style-type: none"> - Premere  per ripristinare i parametri predefiniti - Unità danneggiata
Allarme misura (*1)	MSURA ALTA MSURA BASSA	<ul style="list-style-type: none"> - Regolare la concentrazione del prodotto chimico
Il menu WiFi non è presente nel menu avanzato, ma è presente la scheda WiFi	IL MENU W- FI NON E PRESENTE	<ul style="list-style-type: none"> - Spegnerne l'unità, tenere premuto  e accendere.
Misura dell'errore	MSURA SBAGLIATA	<ul style="list-style-type: none"> - Per favore, reimpostare il parametro di calibrazione , in Advanced Menu fare clic su <u>Reset CAL Item.</u>

(*1 Intervalli misure allarme)

n	Item	Limiti
1	Misura Temp. min	+ 10°C
2	Misura Temp. Max	+ 38°C
3	Misura pH min	6 pH
4	Misura pH Max	8 pH
5	Misura ORP min	+ 600 mV
6	Misura ORP Max	+ 800 mV
7	Misura CL min	0,50 ppm
8	Misura CL Max	2 ppm

15. MOVIMENTAZIONE

Sostituzione dei tubi:

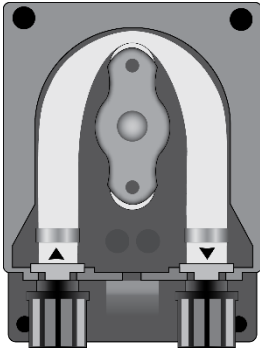

Aprire il coperchio della pompa e rilasciare il tubo tirando il connettore di sinistra verso l'alto.

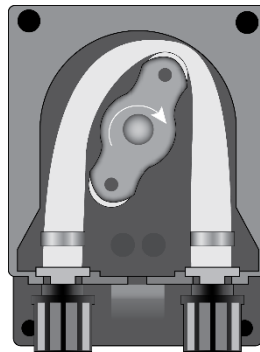

Posizionare il rullo alle ore 7:05, ruotandolo nella direzione della freccia circolare.

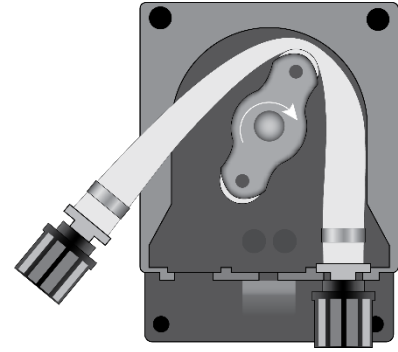

Rilasciare completamente il connettore di sinistra, tenendolo teso verso l'esterno, e ruotare il rullo nella direzione della freccia circolare in modo da liberare il tubo verso il connettore di destra.

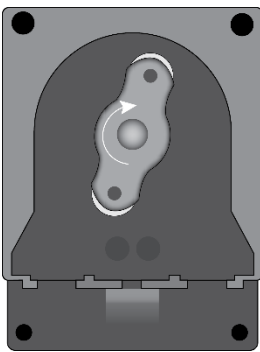

Posizionare il rullo alle ore 7:05, ruotandolo nella direzione della freccia circolare.

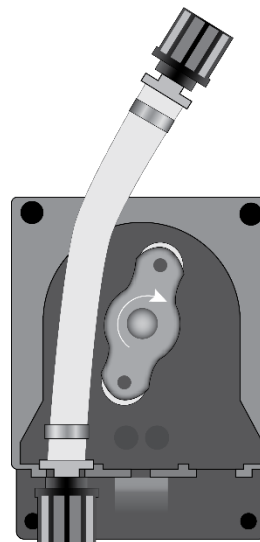

Inserire il connettore di sinistra nell'apposito alloggiamento e far passare il tubo sotto la guida del rullo. Ruotare il rullo nella direzione della freccia circolare, accompagnando contemporaneamente il tubo nella testata della pompa fino a raggiungere il connettore di destra.

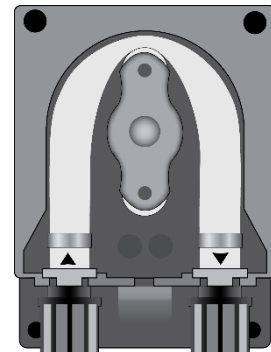

Chiudere il coperchio della pompa e premere sulla superficie in modo da bloccarlo saldamente in posizione.

*Procedura sostituzione tubo valida per 2 e 3 rullini.

16. CONSERVAZIONE DELLA POMPA DOPO L'USO

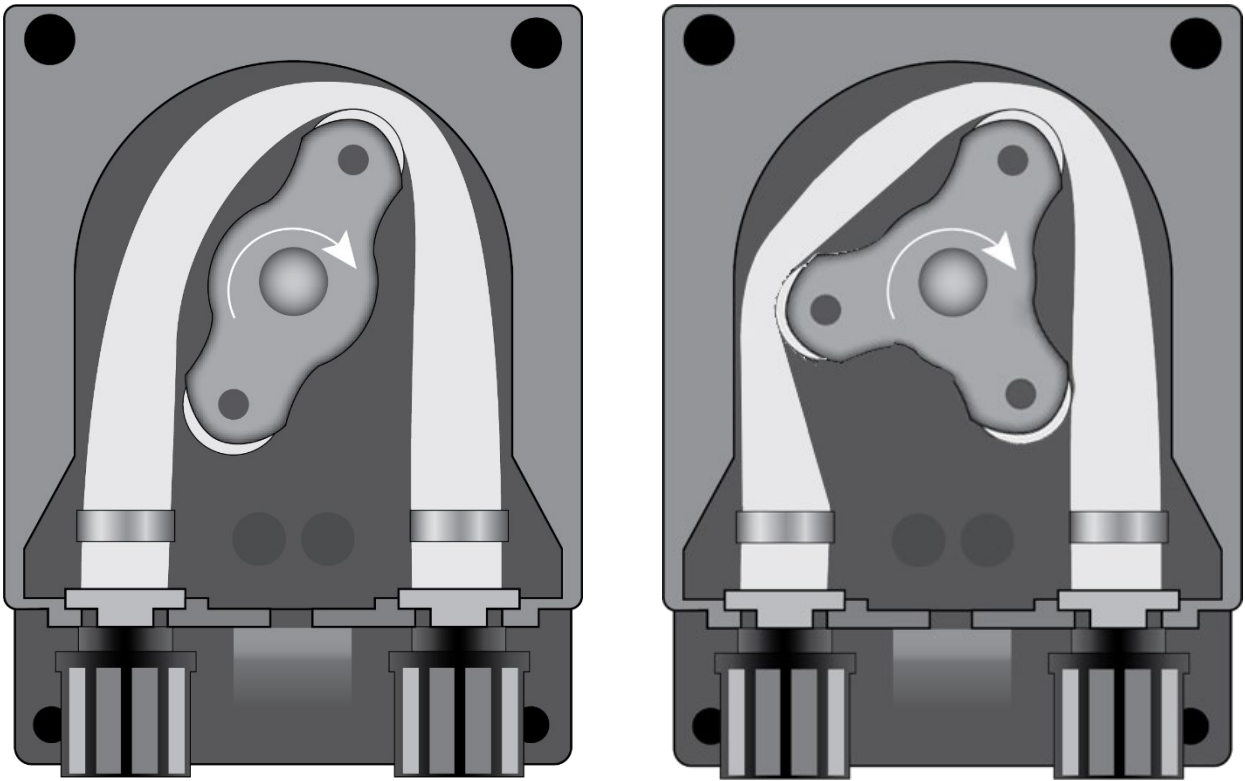

In caso di conservazione del dispositivo di regolazione, pompare acqua pulita attraverso il tubo per risciacquarlo.

Dopodiché posizionare il rullo alle ore 7:05, ruotandolo nella direzione indicata dalla freccia circolare.

Queste due precauzioni permettono di facilitare la riattivazione successiva dell'unità.

PoolDose | pH · ORP · Cloro

Collegamenti elettrici:

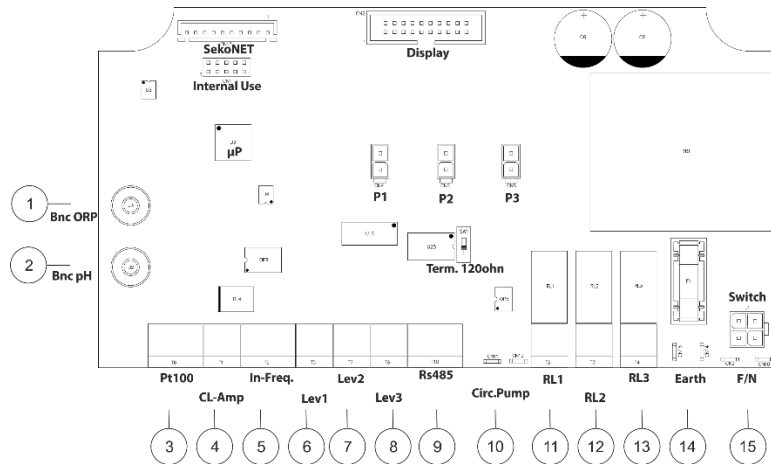

Etichetta connessioni:

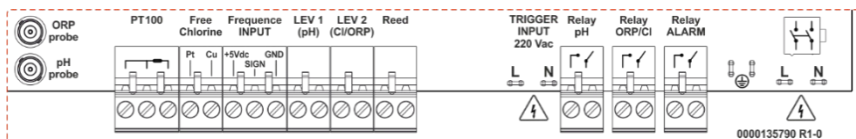

Morsetto	Descrizione	PoolDose pH · ORP	
1	Ingresso sonda	ORP	Sonda ORP
2	Ingresso sonda	pH	Sonda pH
3	Ingresso sonda	TEMP (PT100) A= Sensore temp. con due cavi B= Sensore temp. con tre cavi	
4	Ingresso sonda Cloro libero	Ingresso sonda Cloro libero: Pt: Sensore in platino Cu: Sensore in rame	
5	Ingresso segnale freq.	Portata (Ingresso frequenza) A= Meccanico Reed B= Padwheel a sensore Hall	
6	Livello (serbatoio prodotto)	Sonda livello pH	Sonda livello per serbatoio prodotto
7	Livello (serbatoio prodotto)	Sonda livello Cloro (ORP)	Sonda livello per serbatoio prodotto
8	Livello (serbatoio prodotto)	Portata (Sensore REED)	Sensore portata
9	Porta Seriale	Non Presente	Non Presente
10	Ingresso trigger	Pompa di ricircolo (Ingresso 220Vac)	Fili Fase/Neutro
11	Uscita Relè	RL1 AUX1 pH	Contatto secco
12	Uscita Relè	RL2 AUX2 OPR/Cloro	Contatto secco
13	Uscita Relè	RL3 Allarme	Contatto secco
14	Connettore di terra	Terra	---
15	Alimentazione	220-240 Vac 50-60 Hz (F/N)	---